



ROHDE & SCHWARZ

Test and Measurement
Division

Software Manual

WLAN 802.11A TX Tests

Application Firmware R&S FSP-K90

1300.6850.02

Printed in the Federal
Republic of Germany

Dear Customer,

throughout this operating manual, the abbreviation FSP is used for your Spectrum Analyzer R&S FSP.
R&S® is a registered trademark of Rohde & Schwarz GmbH & Co. KG
Trade names are trademarks of the owners

Contents

1 General Information	1.1
Introduction to FSP-K90 & Wireless LAN Measurements	1.2
Installation.....	1.2
Starting the application	1.4
Exiting the application	1.4
Quick Start Guide	1.5
Setting up the measurement.....	1.5
Performing Level Detection.....	1.7
Performing the main measurement	1.7
Navigation	1.8
Hotkeys	1.8
Softkeys	1.10
Settings Softkeys	1.10
Other Softkeys	1.11
Hardkeys.....	1.12
External Keyboard	1.13
Mouse	1.14
Selecting & Editing Parameters	1.14
Numeric Keypad	1.14
Rollkey	1.15
Cursor Keys	1.15
Selection of a parameter within a settings view.....	1.15
Entry of a numeric value	1.17
Entry of an enumerated value.....	1.19
Entry of a checkbox	1.20
Status Bar & Title Bar	1.21
Title Bar.....	1.21
Status Bar	1.21
Save/Recall.....	1.22
Printing	1.23

2 Measurements & Settings	2.1
Measurements	2.1
IQ measurements	2.2
EVM Vs Symbol	2.3
EVM Vs Carrier	2.4
Constellation Vs Symbol	2.5
Constellation Vs Carrier	2.6
Frequency sweep measurements	2.7
Spectrum Mask	2.7
Spectrum ACPR.....	2.8
Automatic Level Detection	2.8
Running measurements	2.9
Measurement results	2.10
Measurement results	2.10
Results Summary	2.11
General Settings	2.12
Signal Characteristics	2.13
Data Capture Settings	2.14
Capture Time	2.14
Trigger Settings	2.15
IQ Settings	2.15
Demod Settings	2.16
Burst To Analyze Settings	2.17
Tracking Settings	2.18
Markers	2.19
Adjusting Markers	2.19
Marker Zoom.....	2.20
Toggle Marker Display.....	2.20
Assigning Markers to Traces	2.21
Display Settings.....	2.22
3 Measurements in Detail	3.1
Abbreviations.....	3.1
Signal Processing of the IEEE802.11a application	3.1

4 Remote Control	4.1
Description of commands	4.1
Notation.....	4.1
SCPI Commands.....	4.3
ABORt Subsystem	4.3
CALCulate: Subsystem.....	4.4
CALCulate:MARKer Subsystem	4.4
CALCulate:MARKer:FUNcTION Subsystem	4.7
Configure Subsystem	4.8
DISPlay Subsystem	4.12
FETCh – Subsystem.....	4.14
INITiate Subsystem	4.17
INPut Subsystem	4.18
INSTrument Subsystem.....	4.19
SENSe Subsystem	4.20
STATus Subsystem	4.25
TRACe Subsystem	4.28
Trigger Subsystem.....	4.30
Unit Subsystem.....	4.32
Status reporting registers	4.33
Description of the Status Registers	4.35
Table of softkeys with assignment of IEC/IEEE bus commands.....	4.37
Key LINES or Hotkey WLAN.....	4.37
Key DISP.....	4.42
Key LINES	4.43
Key MKR.....	4.43
Key MKR->.....	4.43
Hotkeys	4.44
5 List of Warnings & Error Messages.....	5.1
6 Index.....	6.1

1 General Information

The Rohde & Schwarz FSP-K90 application extends the functionality of the FSP spectrum analyzer to enable Wireless LAN TX-measurements according to IEEE standard 802.11a.

This manual supports the user in working with FSP-K90. It aids the preparation, execution and evaluation of a measurement and gives many helpful hints and examples.

For the user wanting to make a quick start to using FSP-K90, the Quick Start Guide section below works step-by-step through an ordinary measurement. The remainder of this section describes all of the basic information about how the FSP-K90 application works, without covering measurements in detail. A detailed description of all measurement modes, settings and results can be found in section 2. Section 4 covers remote control operation of FSP-K90.

This section covers the following subjects:

Introduction to FSP-K90 & Wireless LAN measurements

- Installation
- Starting the application
- Exiting the application
- Quick start guide – allows the user to get up-and-running in minimum time
- Navigation
- Save/recall – saving & recalling user settings & measurement results
- Printing

Introduction to FSP-K90 & Wireless LAN Measurements

The use of an FSP spectrum analyzer with its high sensitivity enables the accurate and reproducible TX-measurement of wireless LAN Device Under Test (DUT) according to the standards specified for the device:

- Modulation formats:
 - BPSK
 - QPSK
 - 16QAM
 - 64QAM
- Modulation measurements:
 - Constellation diagram
 - Constellation diagram per OFDM carrier
 - I/Q offset and I/Q imbalance
 - Carrier and symbol frequency errors
 - Modulation error (EVM) per OFDM carrier or symbol
 - Amplitude response and group-delay distortion (spectral flatness)
- Transmit spectrum mask
- Capture time selectable up to 4.06 ms, multiple sweeps possible for large number of bursts

Installation

From the analyzer select firmware update.

- Press the **SETUP** hardkey followed by **NEXT**, **FIRMWARE UPDATE** and finally the **FIRMWARE UPDATE** softkey. Following the instructions displayed.

Once the installation has completed the analyzer will reboot.

Once the option has been installed it needs to be activated:

- Start up the analyzer.
- Press the **SETUP** hardkey, followed by the **GENERAL SETUP** softkey and then the **OPTIONS** softkey. A list of the options currently activated is displayed.
- Press the **INSTALL OPTION** softkey. A Dialog is displayed allowing the option key to be entered.

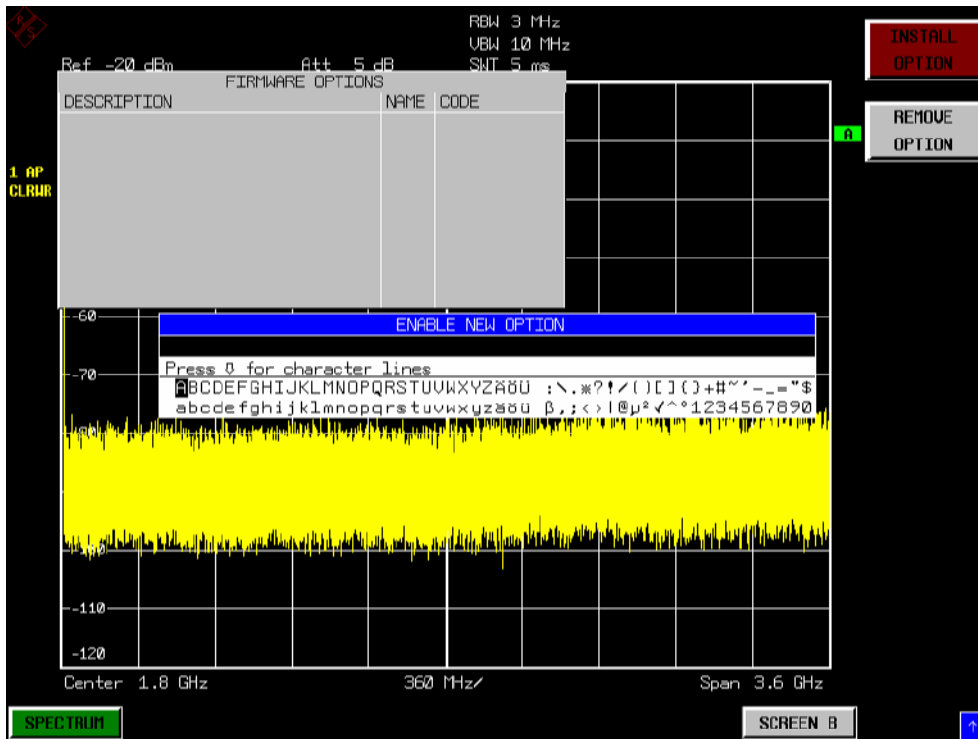

- Enter the option key supplied with the FSP-K90 software.
- When a valid option key has been supplied a dialog will be displayed explaining that a reboot is required to complete this operation. Select OK in this dialog and the instrument will be rebooted
- When the analyzer starts after the reboot a new hotkey will be displayed at the bottom of the display labelled *WLAN*. In addition an entry for the FSP-K90 option will be displayed in the *FIRMWARE OPTIONS* dialog.

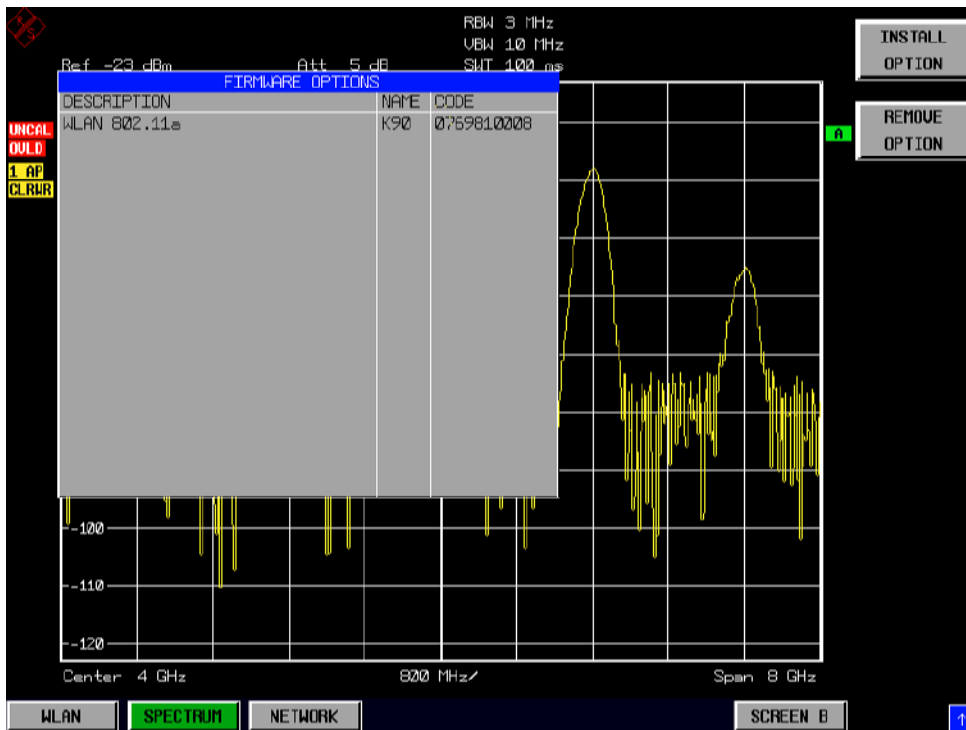

Starting the application

Power up the FSP spectrum analyzer. When FSP-K90 is correctly installed there will be a hotkey labelled *WLAN* at the bottom of the screen. Press the *WLAN* hotkey to start FSP-K90.

Note that if the spectrum analyzer is powered down whilst FSP-K90 is active, then when the spectrum analyzer is powered up again it will start up in the FSP-K90 application.

Exiting the application

To exit the FSP-K90 option, press the *SPECTRUM* hotkey at the bottom of the screen. This will cause the option to exit and the spectrum analyzer to be activated with the same settings as were set when the FSP-K90 option was activated.

Quick Start Guide

This section helps the user to quickly become familiar with FSP-K90 by working step-by-step through an ordinary measurement. (Refer to section 2 for a detailed reference guide.)

For this example a DUT using IEEE 802.11a will be used. The DUT will be connected to the analyzer using the RF input of the analyzer. The DUT will generate a signal modulated using 16QAM

Setting up the measurement

- Start the FSP-K90 application.
- Press the *GENERAL SETTINGS* softkey to open the General Settings view.

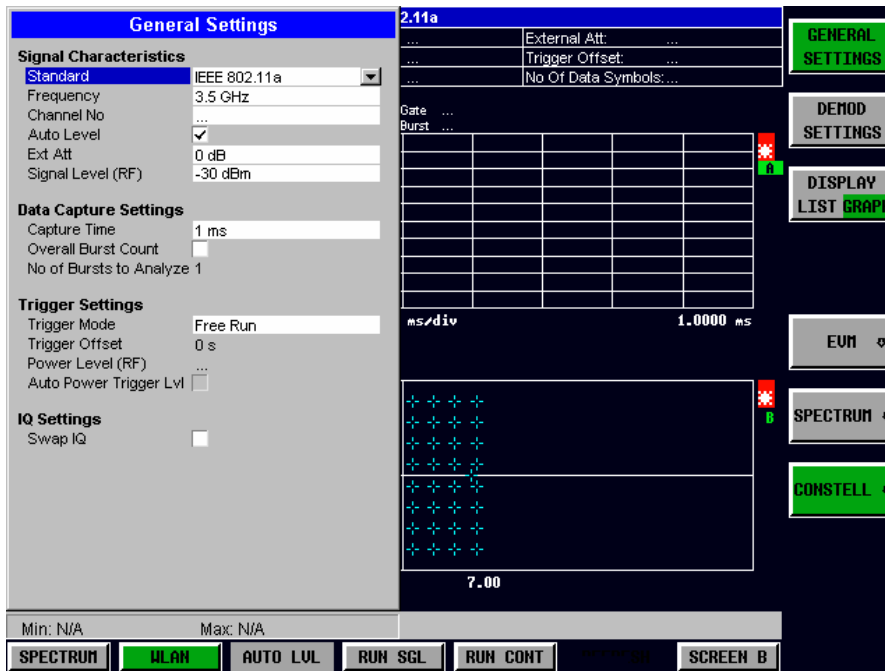

- Select the *Frequency* field and enter the desired frequency to measure. Note that when a valid frequency is entered the *Channel No* field updates.
- Switch Off the *Auto Level* Field. In this example the level detection measurement will be executed manually.

All other settings in this view are sufficient for this example.

- Press the *DEMODO SETTINGS* softkey to open the Demod Settings view

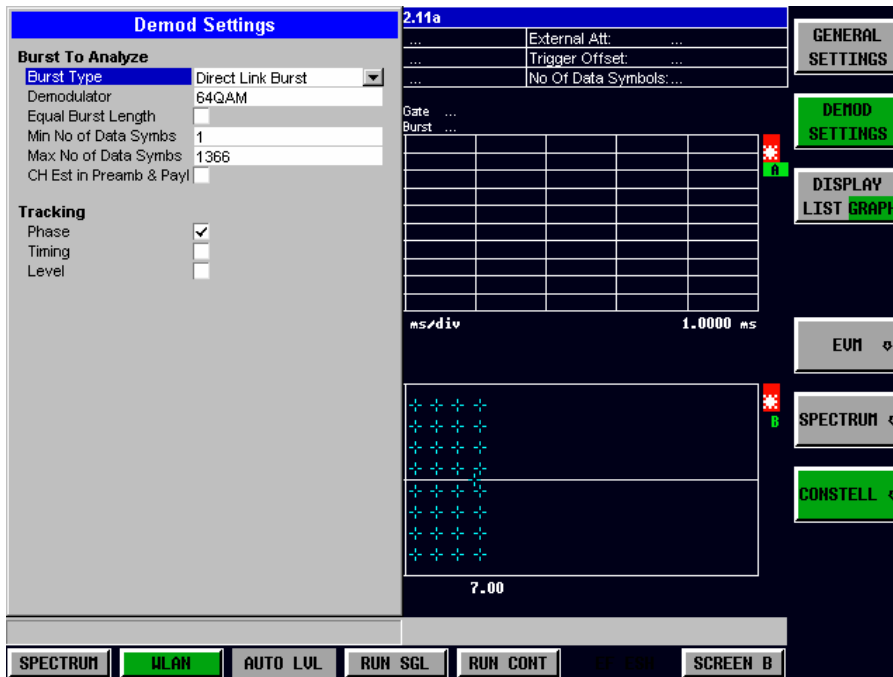

- Enter the modulation scheme used in the *Demodulator* field.

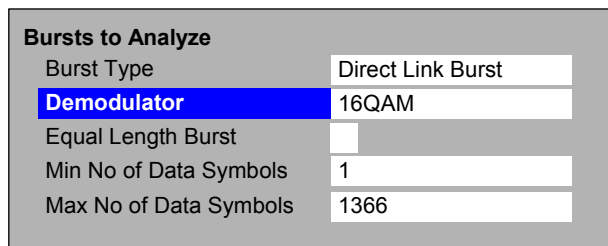

- Close the Demod Settings by pressing the *WLAN* hotkey.

Performing Level Detection

- Connect the DUT to the RF input of the spectrum analyzer. (see Fig. 1-1)

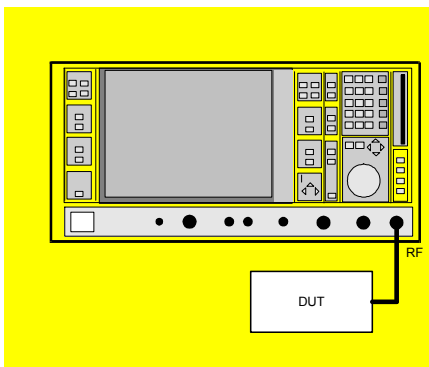

Fig. 1-1 Preparation for level detection

- Start the Level Detection measurement by pressing the *AUTO LVL* hotkey.
- During the level detection measurement the text "*Running ...*" is displayed in the Status Bar at the bottom of the screen.
- After successful level detection, the Status Bar will display "*Measurement Complete*", the signal level field for the selected input will be updated to show the detected signal level and the Magnitude Capture Buffer (Screen A) will be updated to show the zero span trace obtained during the measurement sequence.

Performing the main measurement

After level detection has been successfully completed the main measurement can be started. The set-up for the main measurement is the same as that for the level detection measurement.

- Start the measurement by pressing the *RUN SGL* hotkey.
- During the measurement, the text "*Running...*" is displayed in the Status Bar at the bottom of the screen.

Measurement results are updated once the measurement has completed. The results are displayed in graphical form. The display can be toggled to a tabular list of measurement points by pressing the *DISPLAY* softkey.

Navigation

This section deals with navigation within the option. Navigation here is taken to mean all forms of interaction with the option except for remote control. The different methods of interacting with the option are:

- Hotkeys
- Softkeys
- Hardkeys
- Numeric Keypad
- Roll-key
- Cursor Keys
- External Keyboard
- Mouse

Hotkeys

Hotkeys are allocated to the seven keys at the bottom edge of the screen. On initial start-up of the K90 option, the hotkeys provided are shown in Fig. 1-2. These hotkeys are present at all times once the option has been started.

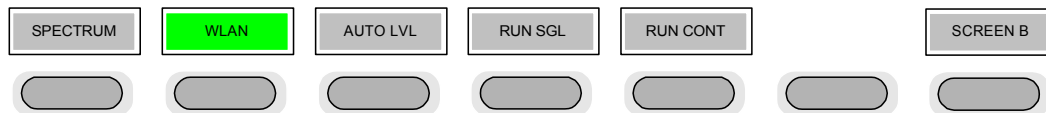
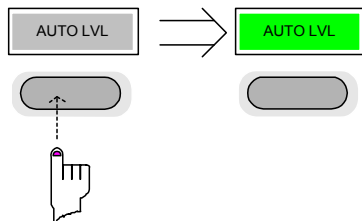

Fig. 1-2 Initial Hotkey menu

A keystroke activates the associated hotkey. An activated hotkey changes colour to green, as shown.



These hotkeys perform the following operations:

SPECTRUM

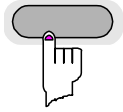

The *SPECTRUM* hotkey exits the FSP-K90 option & returns to the spectrum analyzer with all previous settings restored.

WLAN

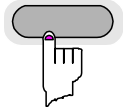

The *WLAN* hotkey returns the user to the main measurement menu of FSP-K90, where measurement results can be seen. All settings views and dialogs are removed from the display, and the default softkey menu is displayed

The *WLAN* hotkey remains green whenever FSP-K90 is active

AUTO LVL

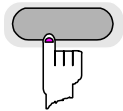

The *AUTO LVL* hotkey starts a automatic level detection measurement.

If another measurement is running then the running measurement will be aborted before the automatic level detection measurement is started.

Pressing the *AUTO LVL* hotkey whilst an automatic level detection measurement is running causes the measurement to be stopped (aborted).

RUN SGL

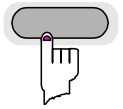

The *RUN SGL* hotkey starts the selected measurement in single sweep mode.

If another measurement is running, such as Calibration or a fixed frequency measurement, the running measurement will be aborted before the single sweep measurement is started.

Pressing the *RUN SGL* hotkey whilst a single frequency range measurement is running causes the measurement to be stopped (aborted).

RUN CONT

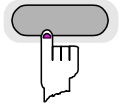

The *RUN CONT* hotkey starts the selected measurement in continuous sweep mode

If another measurement is running then the running measurement will be aborted before the continuous sweep measurement is started.

Pressing the *RUN CONT* hotkey whilst a continuous sweep measurement is running causes the measurement to be stopped (aborted).

SCREEN [A|B]

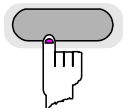

The *SCREEN [A|B]* hotkey selects the specified screen as the active screen.

In full screen mode pressing the *SCREEN [A|B]* hotkey will display the specified screen.

After Pressing the *SCREEN [A|B]* hotkey the label displayed in the hotkey is changed e.g. after pressing the *SCREEN A* hotkey the label of the hotkey is changed to *SCREEN B*. The label indicates which screen will become the active screen after the hotkey is pressed.

Softkeys

Settings Softkeys

The softkeys are assigned to the nine keys on the right-hand side of the display. These enable quick access to all of the parameter settings and measurement screens of the K90 option. Each of the top two softkeys, when pressed, brings up a settings view for a group of parameters. These softkeys are always available (except when using Save/Recall and Print manager or controlling markers) and are as follows:

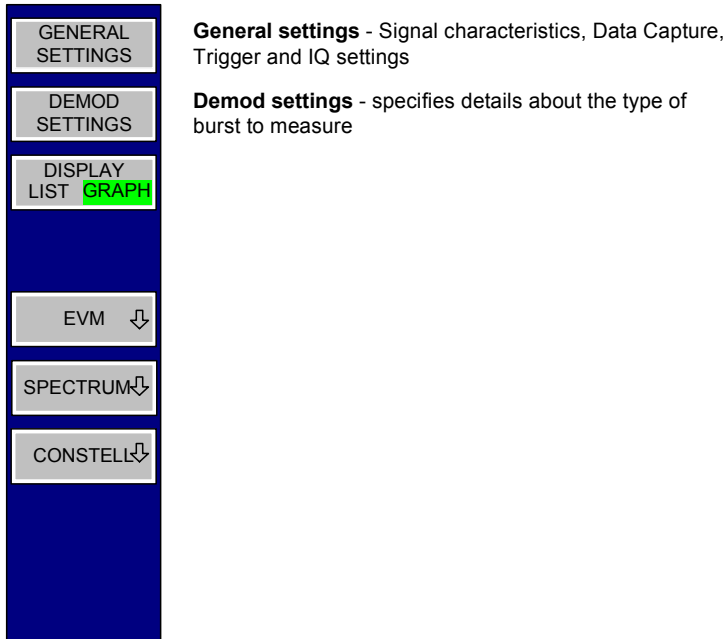

Fig. 1-3 Main softkeys

Each of these groups of settings is described in detail in the Measurements & Settings section of this manual.

Other Softkeys

All other softkeys have different functions depending on the instrument state. Therefore, the labels (text) on the softkeys will vary to reflect their current function. The state of the softkeys is indicated by different appearances and colours, as follows:

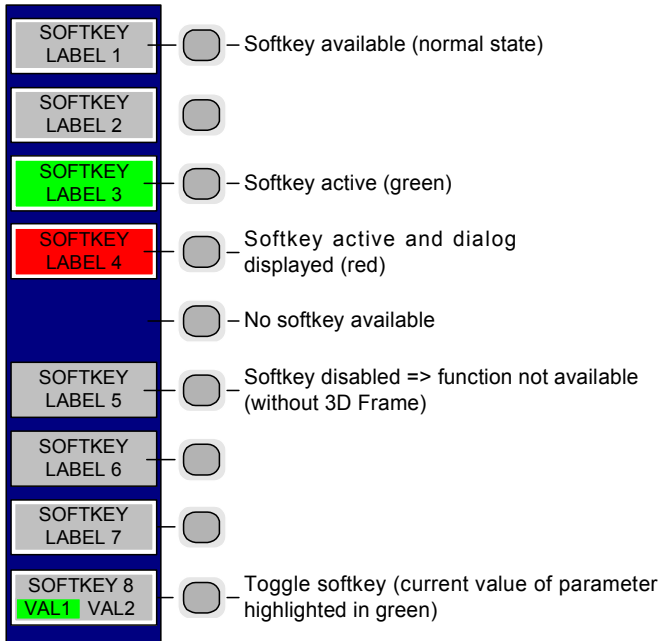

Fig. 1-4 Setup of the softkey area

A softkey in its normal state, where its function is available, is coloured grey with a 3D border.

A softkey that is disabled, because its function is not available, is coloured grey without a 3D border. Softkeys may become disabled because of the state of the instrument or because other settings disable the function associated with the softkey.

An active softkey (highlighted in green) is used when the softkey selects an item or view. For example, the *CARRIER SELECTION* softkey will be highlighted green when the Carrier Selection Dialog is displayed.

A toggle softkey is used to change the value of a parameter that has only two states. Each press of the softkey toggles the value of the parameter. The current parameter value is highlighted in green in the lower half of the softkey label. For example, in the measurement results view, the *DISPLAY* softkey will have either *LIST* or *GRAPH* highlighted in green depending on whether the results are currently displayed as a list of measurement points or graphical trace(s).

When no function is assigned to a softkey then no softkey label will be shown.

Hardkeys

Hardkeys allow quick access to the desired parameter and various functions. The hardkeys supported by the K90 option are as follows (other hardkeys do nothing):

FREQ Hardkey	When the <i>FREQ</i> hardkey is pressed the General Settings view is displayed (if it is not already being displayed) and the <i>Frequency</i> parameter is selected.
AMPT Hardkey	When the AMPT hardkey is pressed the General Settings view is displayed (if it is not already being displayed) and the relevant <i>Signal Level</i> parameter for the selected signal input is selected.
MKR Hardkey	When the MKR hardkey is pressed the main Marker softkey menu is displayed (if it is not already being displayed).
MKR-> Hardkey	When the MKR-> hardkey is pressed the Marker extension softkey menu is displayed (if it is not already being displayed).
SWEEP Hardkey	When the SWEEP hardkey is pressed the General Settings view is displayed (if it is not already being displayed) and the <i>Capture Time</i> parameter is selected.
MEAS Hardkey	When the MEAS hardkey is pressed the Main softkey menu is displayed (if it is not already being displayed).
TRACE Hardkey	When the TRACE hardkey is pressed the General Settings view is displayed (if it is not already being displayed) and the <i>Burst Count</i> parameter is selected.
DISP Hardkey	When the DISP hardkey is pressed the Display softkey menu is displayed (if it is not already being displayed).
FILE Hardkey	When the FILE hardkey is pressed, the Save & Recall softkey menu is displayed, allowing the save & recall of settings and/or measurement results of the K90 option.
PRESET Hardkey	When the PRESET hardkey is pressed the K90 option is exited and a preset will be performed. Note that all options (including FSP-K90) shall also be preset.
HCOPY Hardkey	When the HCOPY hardkey is pressed the print manager softkey menu is displayed, allowing selection of the items to be printed.

External Keyboard

The external keyboard is optional. The keys on the external keyboard that can be used to interact with the K90 option are as follows:

Number keys 0 to 9

Decimal point (“.”) Inserts a decimal point “.” at the cursor position.

Minus key (“-“) Changes the sign of the mantissa or exponent of a numeric parameter. A “-“ is inserted at the cursor position in the case of an alphanumeric parameter.

ESC key Aborts the entry before it has been terminated. The previous value is restored.
Closes the entry field after termination of input.
Closes pop-up dialogs.

ENTER key Terminates the input of dimension quantities. The new value is set.
Invokes the input of parameters or immediately sets the new value.
Selects the highlighted item in drop-down menus.

Left and Right Cursor Keys are used to: Navigate between individual parameters within the setting views and some of the pop-up dialogs.
Navigate between the individual items within drop-down menus.
Move the cursor left & right inside the entry window to reach a particular position in the string during alphanumeric entry.

Up and Down Cursor keys are used to: Navigate between individual parameters within the setting views and some of the pop-up dialogs.
Navigate between the individual items within drop-down menus.
Increment or decrement the value of a parameter during numeric entry.

CTRL keys Used to activate hotkeys. Each of the seven hotkeys is allocated a different function (F) key. To access these hotkeys press CTRL and the corresponding F key together (see Fig. 1-5):

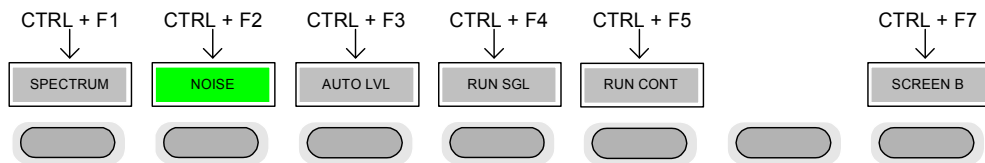

Fig. 1-5 Quick Access to Hotkeys

Function Keys Used to activate softkeys. Each of the nine softkeys is allocated a different function (F) key. To access these softkeys the corresponding F key, as shown below:

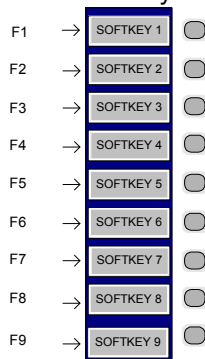

Fig. 1-6 Quick access to softkeys

Mouse

The mouse can be used to select individual parameters within the settings views or data entry dialogs and to activate hotkeys and softkeys. It can also be used to select values from a drop-down list.

Selecting & Editing Parameters

Parameters are set either by numeric or alphanumeric entry or by simple selection from a list of possible values (a drop-down list is used to select an “enumerated” value) or by using checkboxes to turn a parameter setting on and off.

In all cases, the parameter has to be selected by placing focus on it and then editing has to be enabled before its value can be changed.

The rollkey and cursor keys on the front panel are provided for navigation and selection of parameters.

The numeric keypad, rollkey and cursor keys on the front panel and an external keyboard (optional) are provided for the entry of parameter values.

Numeric Keypad



The numeric keypad is provided for entry of numeric parameters. It contains the following keys:

- Number keys 0 to 9
Starts editing of the selected parameter. This enables a new value to be entered for a parameter directly without having to press *ENTER* first. The digit will be displayed as the first digit of the newly entered value. Inserts a digit at the cursor position when editing an alphanumeric parameter.
- Decimal point
Inserts a decimal point “.” at the cursor position.
- Sign key (“-“)
Changes the sign of the mantissa or exponent of a numeric parameter. A “-“ is inserted at the cursor position when editing an alphanumeric parameter.
- Unit keys (GHz/dBm, MHz/dBm, kHz/dB and Hz/dB)
- Provides the numeric value entered with the selected unit and sets the parameter to that value.
The unit keys are all assigned the value “1” for dimensionless quantities or for level entries (e.g. in dB). The unit keys thus assume the function of an *ENTER* key.
- *BACK* key
Deletes the character to the left of the cursor with alphanumeric entry.
- *ESC/CANCEL* key
Aborts the entry of a new parameter value. The previous value is restored. Closes pop-up dialogs.
- *ENTER* key
Enables editing of the selected parameter (using numeric keys or rollkey). Finishes the editing of a parameter value. The new value is set. For an alphanumeric value, the new value is set to that displayed (using the current unit if applicable).
In a drop-down menu, the parameter is set to the currently selected value in the list.

Rollkey

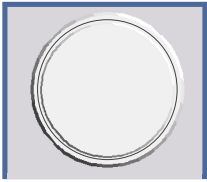



The rollkey has various functions:

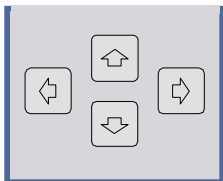

- In a settings view, the rollkey can be used to navigate between individual parameters (the parameter selected being highlighted).
- In drop-down menus, the rollkey can be used to navigate between the individual values for the parameter.
- During numeric entry, the parameter is incremented (by turning clockwise) or decremented (by turning counter-clockwise) at a defined step size (depending on the parameter).
- In setting views and data entry dialogs pressing the rollkey invokes the input of parameters or immediately sets the new value, i.e. pressing the rollkey is like pressing the *ENTER* key.
- In drop-down menus, pressing the rollkey selects the relevant item.

Cursor Keys



The keys  and  are used to:

- Navigate between individual parameters within the setting views and some of the pop-up dialogs.
- Navigate between the individual values within drop-down menus.
- Move the cursor left & right inside the entry window to reach a particular position in the string during alphanumeric entry.

The keys  and  are used to:

- Navigate between individual parameters within the setting views and some of the pop-up dialogs.
- Navigate between the individual items within drop-down menus.
- Increment or decrement the value of a parameter during numeric entry.

Selection of a parameter within a settings view

- Selection using rollkey**
- Press *GENERAL SETTINGS* softkey for example (General settings view is displayed).
 - Rotate the rollkey until reaching the required parameter. Turning the rollkey clockwise selects parameters in the upward direction, turning it counter-clockwise selects parameters in the downward direction.



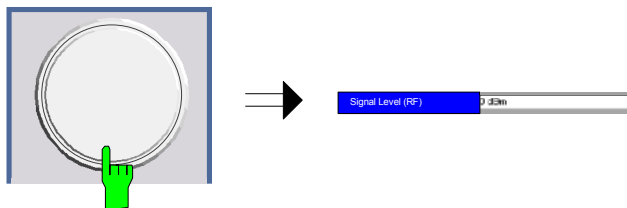

Example: Selecting *Signal Level* (General settings)



Note: When the *Signal Level* parameter is selected its label is highlighted blue.

When the desired parameter is reached press the rollkey to edit the parameter.

Selection using cursor keys

Cursor  ,  ,  or  until obtaining the required parameter. Within a list of parameters, the *Down* and *Right* both move to the next item (down) in the list and the *Up* and *Left* keys both move to the previous item (up) in the list. Within a table of parameters, the cursor keys move the cursor in the direction indicated.

To start editing the parameter, either press the *ENTER* key on the numeric keypad, or press the rollkey.

For numeric parameters, editing can also be started by entering the new value directly from the numeric keypad without pressing the *ENTER* key first.

Example: Selecting *Demodulator* (Demod settings)

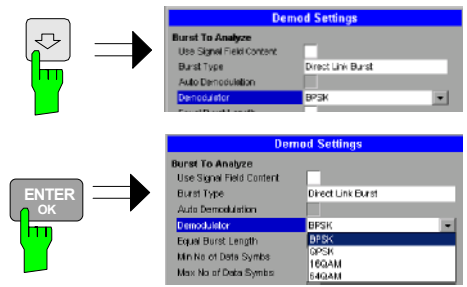

Note: When *ENTER* is pressed, a drop-down menu is displayed, which contains all the available settings to which the *Demodulator* parameter can be set.

Selection using mouse

- Use the mouse to move the cursor to the parameter and press the left mouse button to select the parameter.
- To start editing the parameter, either press the *ENTER* key on the numeric keypad, or press the rollkey.

For numeric parameters, editing can also be started by entering the new value directly from the numeric keypad without pressing the *ENTER* key first.

Selection using external keyboard

- Select parameter using the cursor keys (in the same way as using the cursor keys on the front panel).
- To start editing the parameter, either press the *ENTER* key on the numeric keypad, or press the rollkey.

For numeric parameters, editing can also be started by entering the new value directly from the numeric keypad without pressing the *ENTER* key first.

Entry of a numeric value

Once a parameter has been selected (see above), a new value for a numeric parameter can be entered in a number of ways. With the exception of entry via the number keys, to start editing the parameter, either press the *ENTER* key on the numeric keypad, or press the rollkey before following the instructions below.

If an error occurs, for example, the entered value is out of range, then the new value will not be accepted for the parameter setting.

Entry using number keys (numeric keypad)

- Enter required value using the number keys.

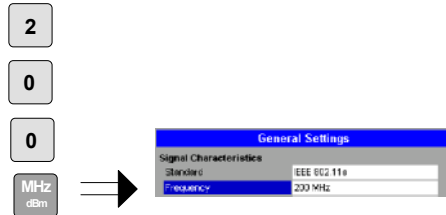

Example: To enter 200 MHz



Note: *The parameter is not set to the new value until either one of the unit keys on the numeric keypad, the ENTER or the rollkey is pressed.*

If the new value is not valid, then a message box is displayed and the entered value will be replaced with a valid value. For example, when a value above the maximum allowed is entered, then the maximum value allowed will be shown in the entry box. The parameter will still be ready for editing so that another value can be entered if desired.

Entry using cursor keys

- Cursor  or  until obtaining the required value.

The application prevents the minimum and maximum values of the parameter from being exceeded and displays an “Out of range” message box if attempted.

N.B The cursor keys increment/decrement a parameter value in large steps.

Example: Cursor down to 100MHz

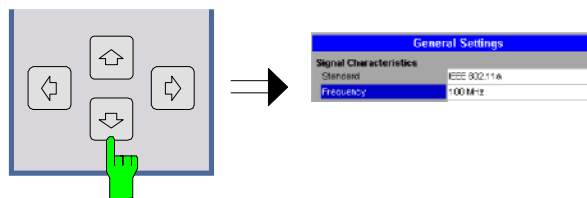

Note: *Each change of the parameter value takes place immediately. No other keys need to be pressed.*

Entry using rollkey

- Rotate the rollkey until reaching the required value.

Turning the rollkey clockwise increases the value, turning it counter clockwise decreases the value.

The application prevents the minimum and maximum values of the parameter from being exceeded and displays an "Out of range" message box if attempted.

N.B The rollkeys increment/decrement a parameter value in small steps

Example: Rotate to 200MHz

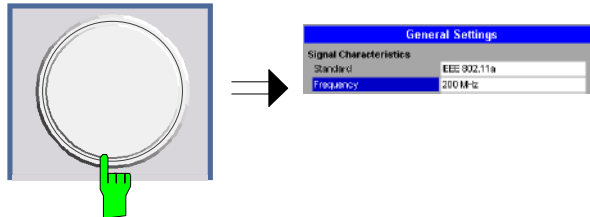

Note: *Each change of the parameter value takes place immediately. No other keys need to be pressed.*

Entry using external keyboard

- Enter value using number keys 0 – 9 in the same way as for using the number keys on the numeric keypad (see above).

Terminating the entry

- Press one of the unit keys on the numeric keypad.

The unit is entered in the parameter's edit box and the new parameter value is set immediately.



- Press the *ENTER* key (on numeric keypad or external keyboard) or press the rollkey.

The new parameter value is set immediately.

Note: *Pop-up dialogs, where used, do not close automatically. They can be closed by pressing the ESC key.*

In both cases, if the new value is not valid, then a message box is displayed and the entered value will be replaced with a valid value. For example, when a value above the maximum allowed is entered, then the maximum value allowed will be shown in the entry box. The parameter will still be ready for editing so that another value can be entered if desired.

Correcting the entry

- Position the cursor to the right of the digit which is to be deleted using the cursor keys  or .
- Press the BACK key. The digit to the left of the cursor is deleted.
- Enter new digits. Each digit is inserted to the left of the cursor, the other digits are shifted right.

Aborting the entry

- Press the *ESC* key during parameter editing.

The original parameter value is restored. The new entry is deleted.

- If a pop-up dialog is displayed, press the *ESC* key again.



The entry window is closed, the original value remains active.

Entry of an enumerated value

Once a parameter has been selected (see above), a new value for an enumerated parameter can be entered in a number of ways. To start editing the parameter, either press the *ENTER* key on the numeric keypad, press the rollkey or left click with the mouse on the drop down button before following the instructions below.

Note: *When the rollkey or ENTER is pressed, a drop-down menu is displayed, which contains all the available settings that may be selected for the parameter.*

Selection of setting using cursor keys

- Cursor  or  until obtaining the required setting.
- Press *ENTER* on external keyboard or numeric keypad, or press rollkey to select the desired setting of parameter.

Note: *Currently selected setting of the parameter is highlighted blue. Pressing ENTER sets the new setting of the parameter immediately.*

Selection of setting using rollkey

- Rotate the rollkey until reaching the required setting.
- Press rollkey to select setting.

Example: Select *Mode* parameter.

Note: *Currently selected setting of the parameter is highlighted blue. Pressing the rollkey sets the new setting of the parameter immediately.*

Selection of setting using mouse

- When the parameter is selected and ready for editing, select a new setting using the mouse by left-clicking on the new setting from the drop-down list. The new setting of the parameter is set immediately.

Selection of setting using external keyboard

- Select setting using cursor keys.
- Press *ENTER* to set the parameter to the new value.

Entry of a checkbox

A checkbox is used for parameter settings that are either On or Off (Boolean settings). A checkmark (✓) appears in the box when the setting is On; the checkbox is empty when the setting is Off.

Once a parameter has been selected (see above), a new value for a Boolean parameter can be entered in a number of ways. Because Boolean parameters are very simple, it is not necessary to press the *ENTER* key on the numeric keypad or to press the rollkey in order to edit them.

Toggle between the two states of a checkbox using rollkey

- Press the rollkey to toggle between the two states.

Example: Turn *Auto Level* setting to Off

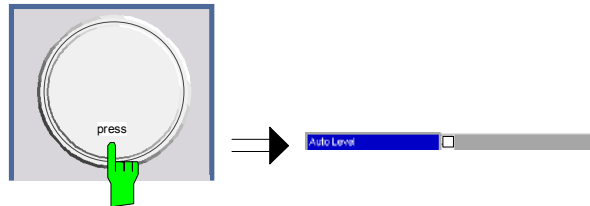

Note: The checkbox is empty when the settings is Off

Toggle between the two states of a checkbox using numeric keypad

- Press the *ENTER* key to toggle between the two states.

Example: Turn *Auto Level* setting to On



Toggle between the two states of a checkbox using a mouse

- Left-click on the checkbox to toggle between the two states.

Toggle between the two states of a checkbox using external keyboard

- Press *ENTER* to toggle between the two states.

Status Bar & Title Bar

Title Bar

The title bar is visible at the very top of the display when FSP-K90 is active and no settings views are displayed.



Fig. 1-7 Title Bar

The centre of the title bar shows the wireless LAN standard applicable to the current measurement

Status Bar

The main status bar is displayed at the bottom of the display, just above the hotkeys.

When a parameter in a settings view is selected, the status bar will display the minimum and maximum, settings for the selected parameter (see Fig. 1-8).

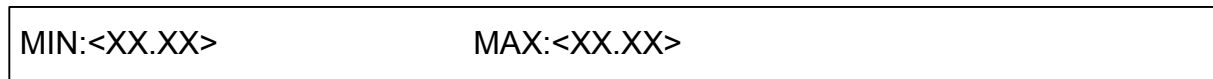

Fig. 1-8 Status Bar

When a parameter whose value is enumerated or Boolean in type is selected in any dialog, the status bar will show “N/A” displayed for the minimum and maximum, since the minimum and maximum values are “Not Applicable.”

At other times, the status bar shows the current measurement status along with detailed information about the progress through any running measurement.

The status bar is also used to display warning and error messages to the user. In order to highlight these messages, warning messages are displayed with a blue background and error messages with a red background. Refer to Section 0 for a list of warning and error messages.

Save/Recall

This section of the user manual describes the Save/Recall facility of the option.

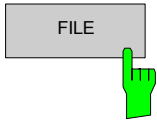

The *FILE* hardkey brings up the Save/Recall softkey menu. Any settings views on display when the save/recall softkey menu is displayed shall be closed.

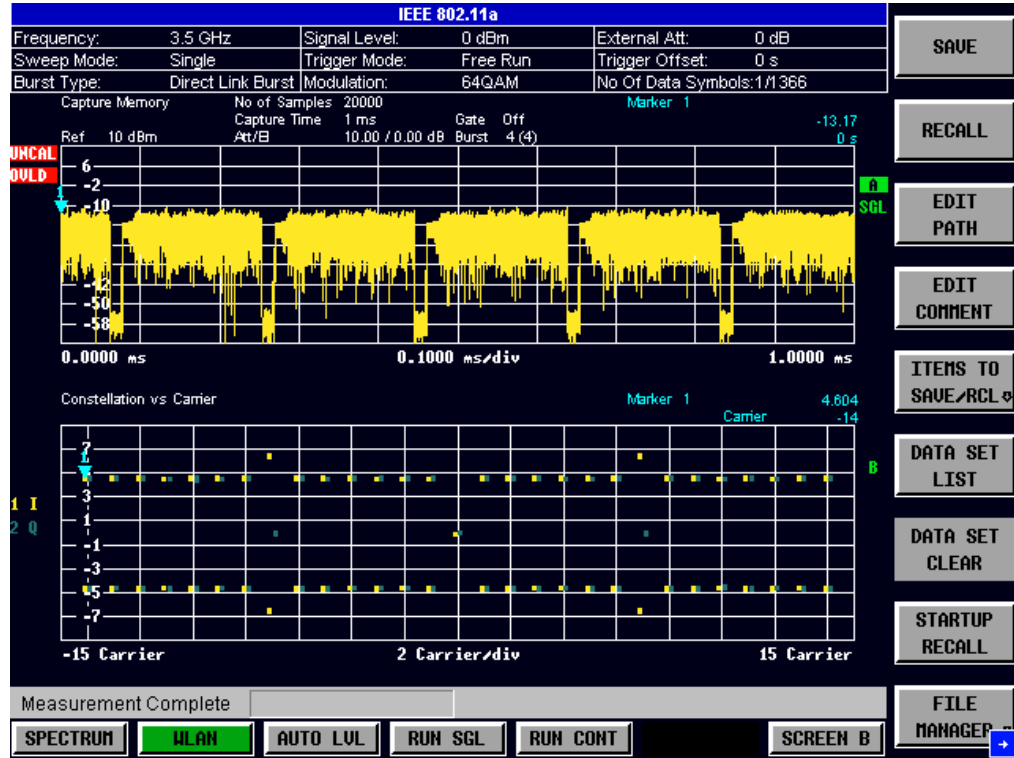

Fig. 1-9 Save/Recall softkey menu

The save/recall facility provided by FSP-K90 is exactly the same as that provided by the host analyser. Refer to the user manual for the spectrum analyzer for details of the save/recall facility operation.

The save/recall facility in FSP-K90 provides the following items that can be saved and/or recalled:

- Current Settings All user settings provided by FSP-K90
- All Traces All current trace results
- Raw IQ Data Allows the raw IQ trace results to be stored. When recalled the data is reprocessed to generate results

To close the save/recall softkey menu and return to the main FSP-K90 softkey menu, press the *WLAN* hotkey.

Printing

This section of the user manual describes print facility of the option

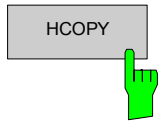

The *HCOPY* hardkey brings up the print softkey menu. Any settings views on display when the print softkey menu is displayed shall be closed.

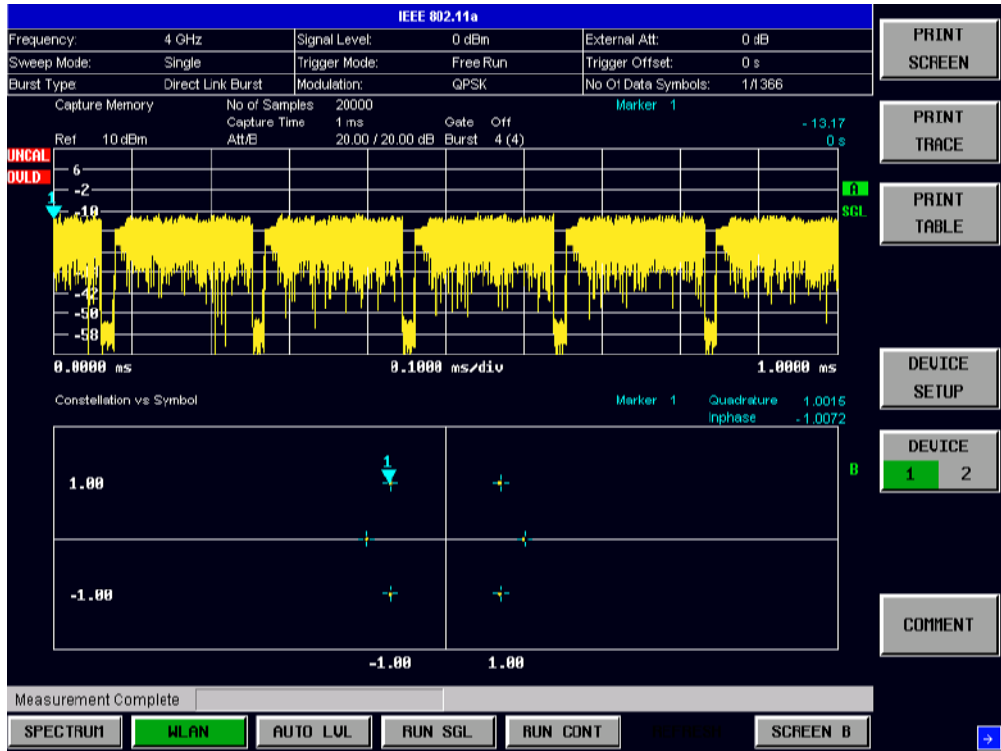

Fig. 1-10 Print softkey menu

The print facility provided by FSP-K90 is exactly the same as that provided by the host analyser. Refer to the user manual for the spectrum analyzer for details of the print facility operation.

To close the print softkey menu and return to the main FSP-K90 softkey menu, press the *WLAN* hotkey.

2 Measurements & Settings

This section contains a detailed description of all measurement modes, settings & results. It covers the following subjects:

- Measurement modes
- Running measurements
- Measurement results
- General settings
- Demodulation settings
- Gate settings
- Marker settings
- General hints about measurements

Measurements

FSP-K90 provides two main measurement types:

- IQ Measurements
- Frequency Sweep Measurements

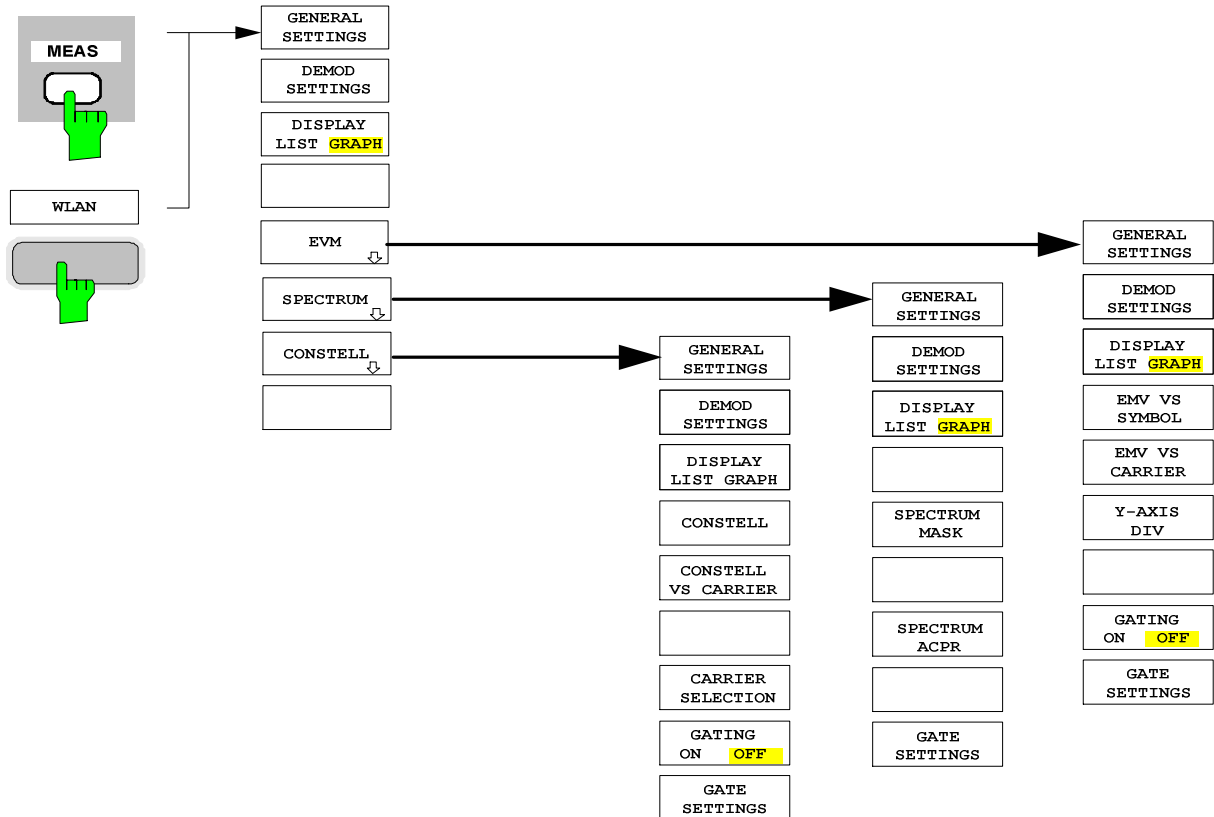

IQ measurements

The following measurements results are obtained in IQ measurement mode:

- EVM Vs Symbol
- EVM Vs Carrier
- Constellation Vs Symbol
- Constellation Vs Carrier

For each of the above results the Magnitude Capture Buffer display is available.

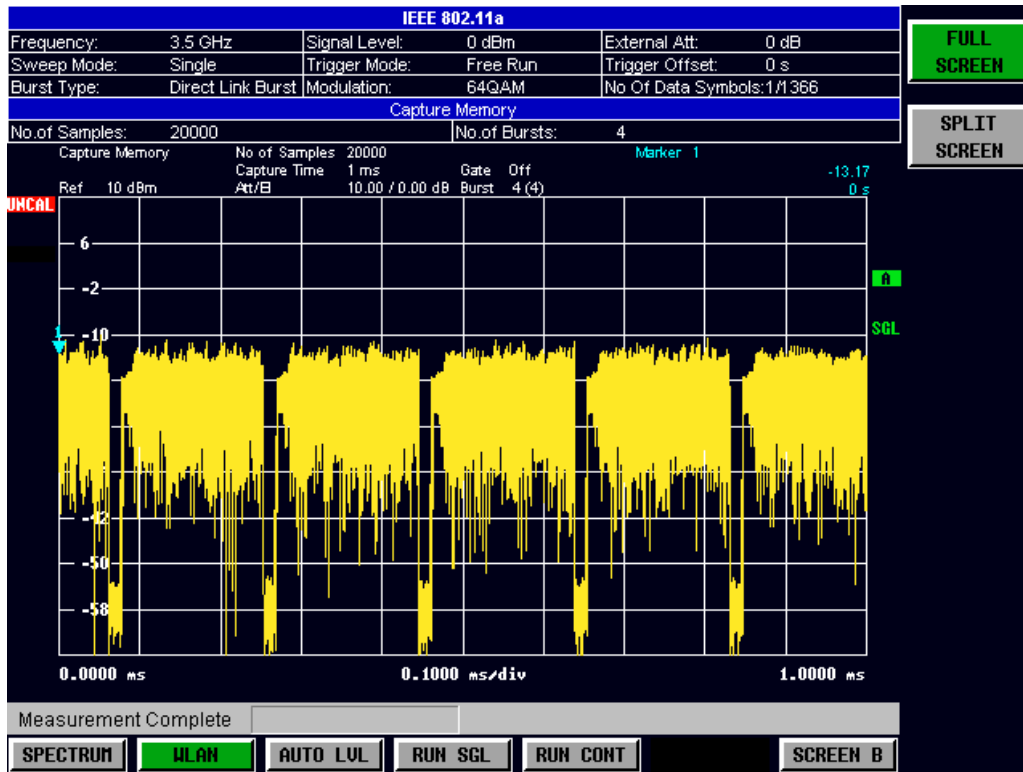

Fig. 2-1 Magnitude Capture Buffer Results

The Magnitude Capture buffer shows the complete range of captured data for the last sweep.

All IQ measurements process the same signal data and as such all IQ measurement results are available after a single IQ measurement execution.

IQ measurements can be run in split screen mode (allowing both the Magnitude Capture Buffer Display and the selected IQ measurement results to be displayed simultaneously) or in full screen mode (with either the Magnitude Capture Buffer Display or the selected IQ measurement results displayed).

EVM Vs Symbol

EVM VS SYMBOL

The EVM Vs Symbol measurement results are selected by pressing the *EVM* softkey in the main measurement softkey menu followed by the *EVM Vs SYMBOL* softkey

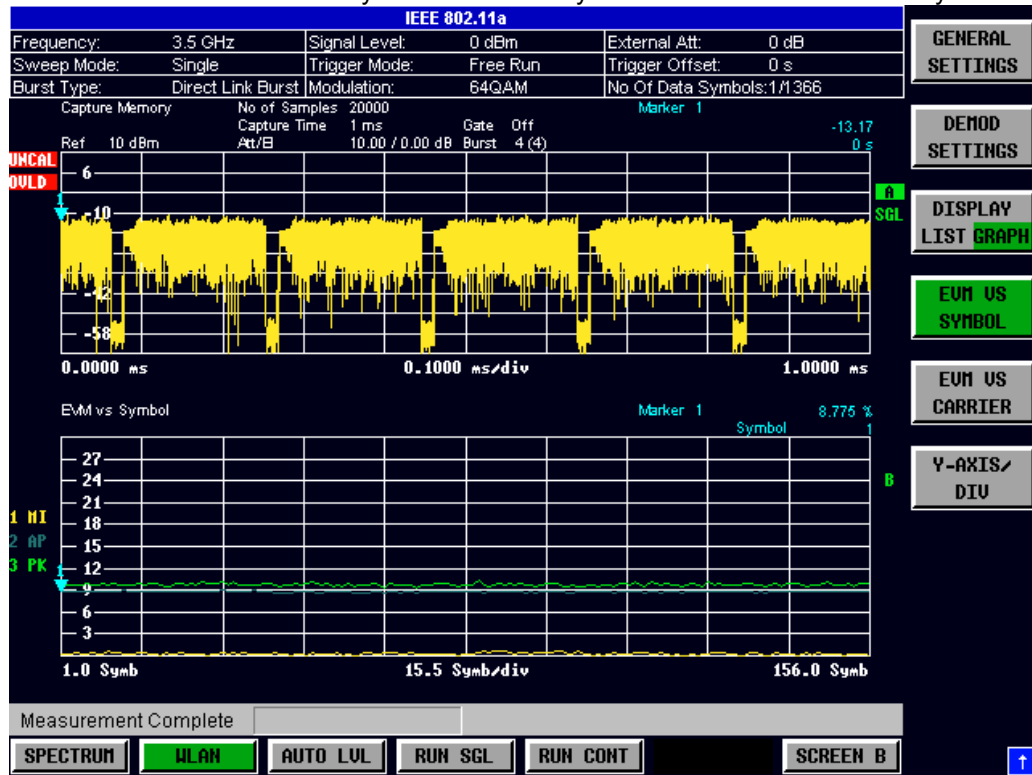

Fig. 2-2 EVM Vs Symbol

The EVM Vs Symbol results display shows the minimum, average and maximum EVM measured over the full range of the measured input data. The results are displayed on a per-symbol basis.

The scaling of the Y-Axis can be modified to allow the results to be scaled to an optimum level

Y AXIS/ DIV

Pressing *Y AXIS/ DIV* softkey displays a pop-up dialog which allows the step size for the Axis to be defined

EVM Vs Carrier

EVM VS CARRIER

The EVM Vs Carrier measurement results are selected by pressing the *EVM* softkey in the main measurement softkey menu followed by the *EVM Vs CARRIER* softkey.

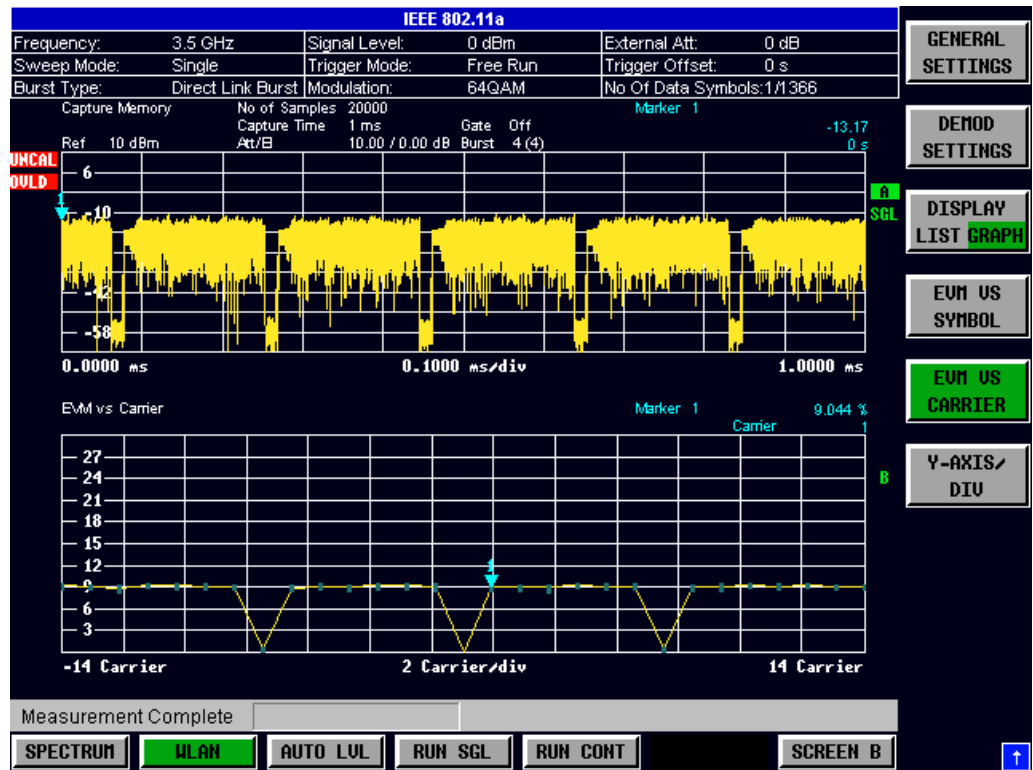

Fig. 2-3 EVM Vs Carrier Results

The EVM Vs Carrier results display shows the all EVM values recorded on a per-carrier basis over the full set of measured data. An average trace is also displayed. Note the results are restricted to carriers -14 to +14 (inclusive)

The scaling of the Y-Axis can be modified to allow the results to be scaled to an optimum level

Y AXIS/ DIV

Pressing *Y AXIS/ DIV* softkey displays a pop-up dialog which allows the step size for the Axis to be defined

Constellation Vs Symbol

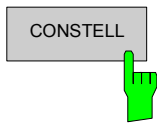

The Constellation diagramm is selected by pressing the *CONSTELL* softkey in the main measurement softkey menu followed by the *CONSTELL* softkey

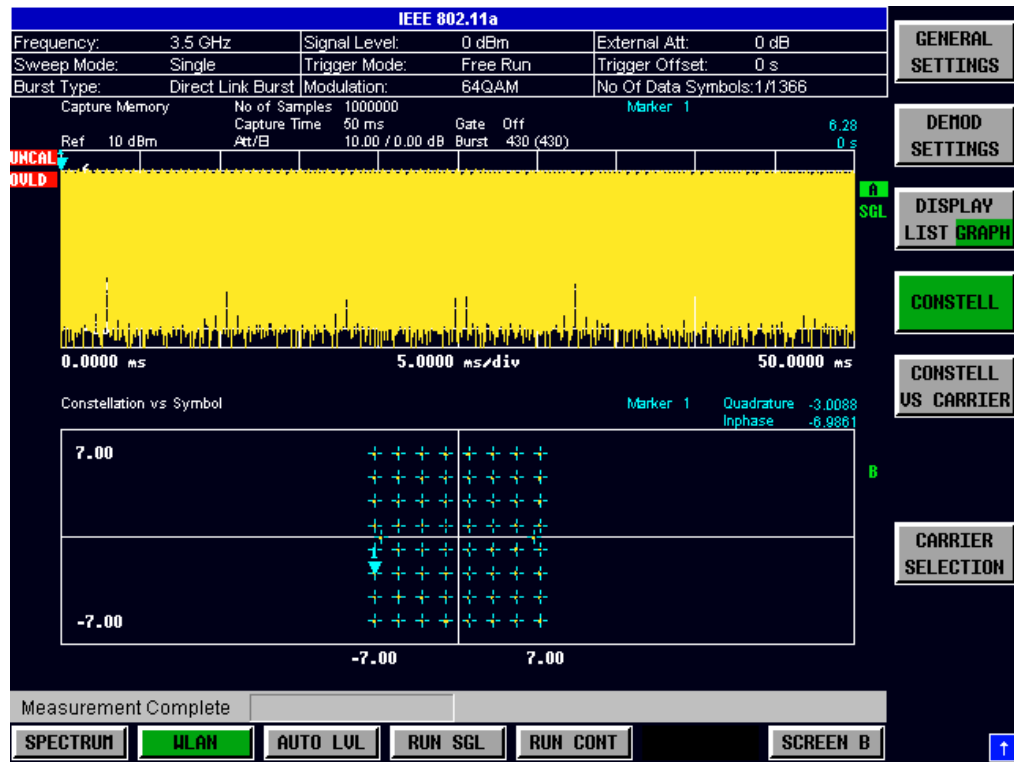
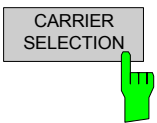

Fig. 2-4 Constellation Vs Symbol Results

The Constellation display shows the Inphase and Quadrature phase results over the full range of the measured input data. The ideal points for the selected modulations scheme are displayed for reference purposes.

The amount of data displayed in the Constellation results display can be reduced by selecting the carrier or carriers for which data is to be displayed



Pressing *CARRIER SELECTION* softkey displays a pop-up dialog which allows the carrier for data display to be selected. Either a specific carrier number or pilots only can be selected. Selecting All Carriers allows all the results to be displayed. Note that carrier selection is restricted to carriers -14 to +14 (inclusive).

Constellation Vs Carrier

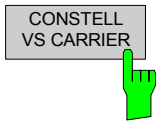

The Constellation Vs Carrier measurement results are selected by pressing the *CONSTELL* softkey in the main measurement softkey menu followed by the *CONSTELL VS CARRIER* softkey.

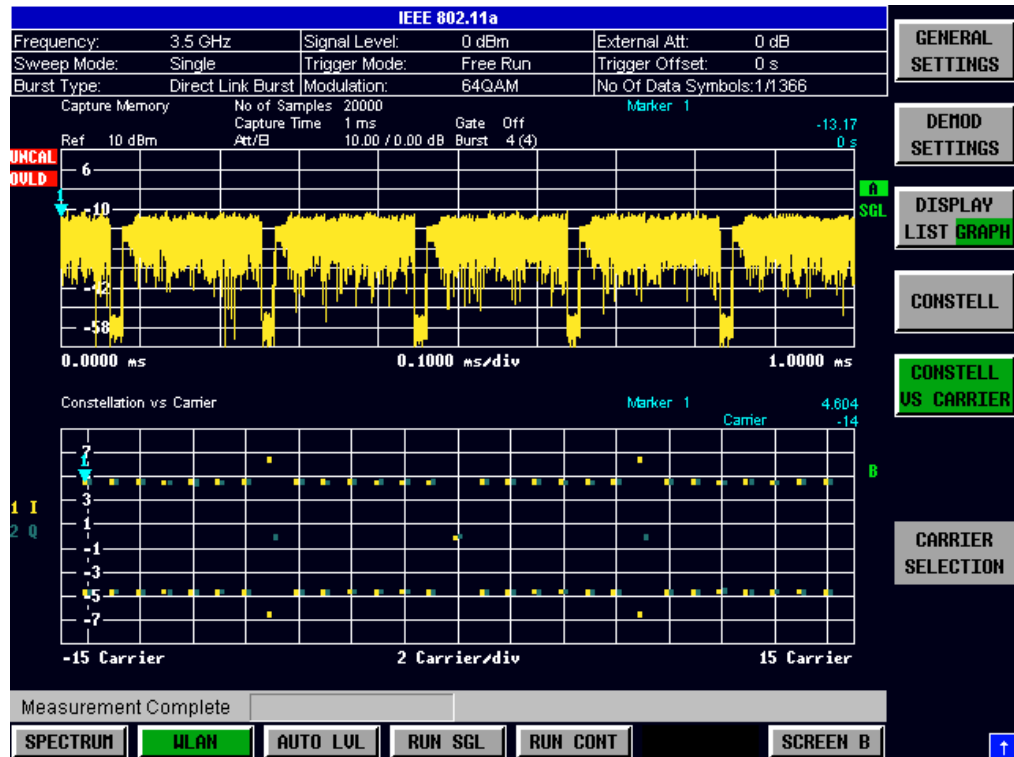

Fig. 2-5 Constellation Vs Carrier Results

The Constellation Vs Carrier results display shows the Inphase and Quadrature phase results over the full range of the measured input data plotted on a per-carrier basis. The magnitude of the Inphase and Quadrature part is shown on the Y-axis, both are separated by different colors (I-> yellow, Q->blue). Note the results are restricted to carriers -14 to +14 (inclusive)

Frequency sweep measurements

The following measurements results are obtained in frequency sweep mode:

- Spectrum Mask
- Spectrum ACPR

The frequency sweep measurements use different signal data to IQ measurements and as such it is not possible to run an IQ measurement and then view the results in the frequency sweep measurements and vice-versa. Also because each of the frequency sweep measurement use different settings to obtain signal data it is not possible to run a frequency sweep measurement and view the results in another frequency sweep measurement.

All frequency sweep measurements are run in full screen mode.

Spectrum Mask

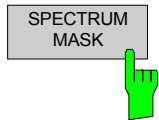

The Spectrum Mask measurement results are selected by pressing the *SPECTRUM* softkey in the main measurement softkey menu followed by the *SPECTRUM MASK* softkey

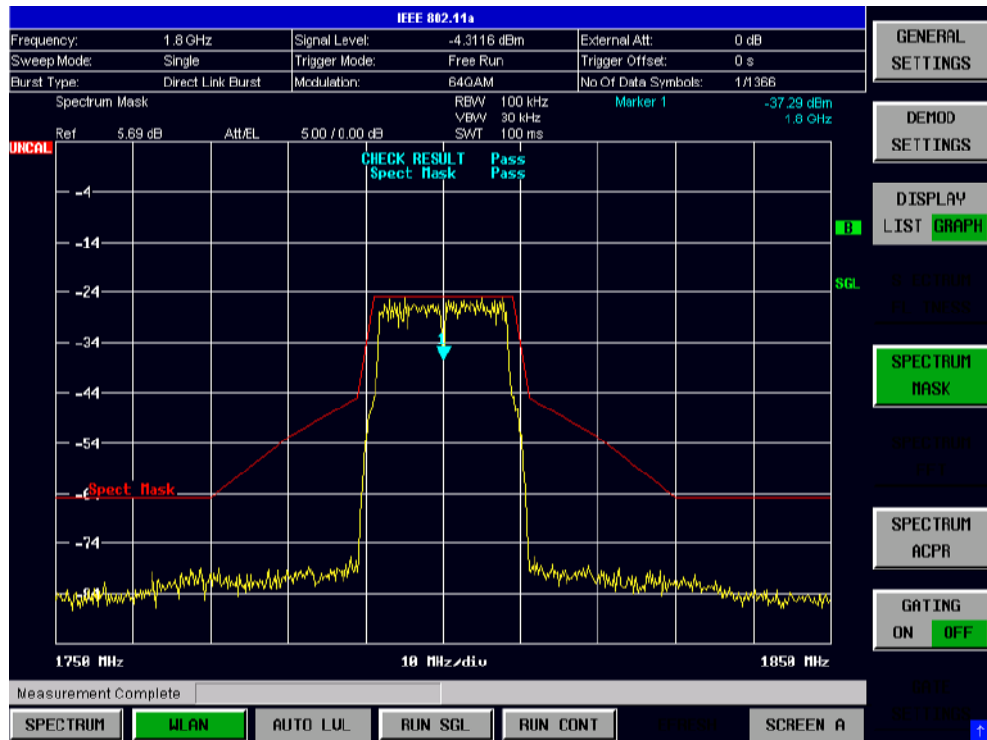
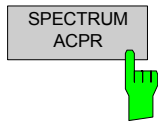

Fig. 2-6 Spectrum Mask Results

The Spectrum Mask results display shows power against frequency. The span of the results is 100MHz around the specified measurement frequency. A limit line representing the spectrum mask specified for the selected standard is displayed and an overall pass/fail status is displayed for the obtained results against this limit line.

Spectrum ACPR



The Spectrum Mask measurement results are selected by pressing the *SPECTRUM* softkey in the main measurement softkey menu followed by the *SPECTRUM ACPR* softkey



Fig. 2-7 Spectrum ACPR Results

The Spectrum ACPR (Adjacent Channel Power (Relative)) is similar to the Spectrum Mask measurement, and provides information about leakage into adjacent channels. The results show the relative power measured in the three nearest channels either side of the measured channel. This measurement is the same as the Adjacent Channel Power measurement provided by the Spectrum Analyzer.

Automatic Level Detection

Automatic level detection allows the Signal Level setting to be calculated from the input signal.

Automatic level detection can be performed in one of two ways:

- Pressing the *AUTO LVL* hot-key
- Setting *Auto Level* in the General Settings view to ON

Running the Automatic Level Detection by pressing the *AUTO LVL* hot-key allows the level detection to be run at any time. Once the Automatic Level Detection has completed the trace is displayed in the Magnitude Capture Buffer display.

Running the Automatic Level Detection by Setting *Auto Level* in the General Settings view to ON means that an Automatic Level Detection measurement is executed before each main measurement sweep. When running the Automatic Level Detection this way no trace for the Automatic Level Detection measurement is displayed. This way of running the Automatic Level Detection will cause measurements to run more slowly and as such it is recommended that Automatic Level Detection is only run in this way when the speed of measurement is not important or when running continuous measurements are being run with a signal which varies in level from one sweep to the next.

Running measurements

To start a measurement, press the *RUN SGL* hotkey (single) or *RUN CONT* hotkey (continuous).

Note that if one measurement is started whilst another measurement is in progress, for example, a single measurement is started whilst a continuous measurement is in progress, then the first measurement will be aborted and the new measurement started immediately.

During a measurement, the text "*Running...*" is displayed in the Status Bar at the bottom of the screen. After successful completion of a single measurement, the Status Bar will display "*Measurement Complete*"

Measurement results

Measurement results

The tabular section below the title bar shows the overall measurement settings used to obtain the current measurement results.

IEEE 802.11a					
Frequency:	4 GHz	Signal Level:	0 dBm	External Att:	0 dB
Sweep Mode:	Single	Trigger Mode:	Free Run	Trigger Offset:	0 s
Burst Type:	Direct Link Burst	Modulation:	64QAM	No Of Data Symbols:	1/1366

Fig. 2-8 Overall measurement settings summary

The settings summary includes the following information:

- Frequency – The frequency of the measured input signal. Note that no value is displayed in this field when Baseband input is selected.
- Sweep Mode - Shows “Single” for a single measurement and “Continuous” for a continuous measurement.
- Burst Type - The type of burst being analyzed.
- Signal Level - The expected mean signal level for the input signal
- Trigger Mode - The trigger source used to start the measurement sweep
- Modulation - Shows either the settings of the *Demodulator* or *PSDU Modulation to Analyze* from the Demod Settings view depending on which parameter is active.
- External Att - The attenuation (positive values) or gain (negative values) applied to the signal external (ie. before the RF- or IQ- connector of the spectrum analyzer)
eg.
External Att = 10dB means that before the RF-connector of the FSP a 10dB attenuator is used
External Att = -20dB means that before the RF-connector of the FSP a amplifier with 20dB gain is used
- Trigger Offset - The trigger delay (positive value) or pre-trigger time (negative value) applied to the trigger.
- No Of Data Symbols - shows the minimum and maximum number of data symbols that a burst may have if it is to be considered in results analysis.

Results Summary

The results summary table is displayed for IQ measurements when the display mode is set to List. This table shows the overall measurement results and provides limit checking for result values in accordance with the selected standard.

IEEE 802.11a						
Frequency:	3.5 GHz	Signal Level:	0 dBm	External Att:	0 dB	
Sweep Mode:	Single	Trigger Mode:	Free Run	Trigger Offset:	0 s	
Burst Type:	Direct Link Burst	Modulation:	64QAM	No Of Data Symbols:	1/1366	
Result Summary for Carrier -14...+14						
No. of Bursts	4					
	Min	Mean	Limit	Max	Limit	Unit
EVM Car -14...+14	8.74	* 8.78	5.62	* 8.85	5.62	%
	-21.17	* -21.13	-25.00	* -21.06	-25.00	dB
EVM Data Car -14...+14	9.07	* 9.11	5.62	* 9.18	5.62	%
	-20.85	* -20.81	-25.00	* -20.74	-25.00	dB
EVM Pilot -7 and +7	0.38	0.43	39.81	0.52	39.81	%
	-48.47	-47.31	-8.00	-45.73	-8.00	dB
IQ Offset	-37.51	-37.40	-15.00	-37.25	-15.00	dB
Gain Imbalance	-0.12	-0.10		-0.06		%
	-0.01	-0.01		-0.01		dB
Quadrature Offset	-0.07	-0.06		-0.04		°
Center Frequency Error	-409.38	-410.05	± 70000	-410.87	± 70000	Hz
Symbol Clock Error	-0.06	-0.04	± 20	-0.57	± 20	ppm
Measurement Complete						
SPECTRUM WLAN AUTO LUL RUN SGL RUN CONT SCREEN B						

Fig. 2-9 Result Summary Table

Result values which are within the limit as specified by the standard are displayed in green. Result values which are within the limit but inside the margin area around the limit are displayed in yellow. Result values which are outside of the limits specified by the standard are displayed in red with a ‘*’ to the left. Results which have no limits specified by the standard are displayed in white. Limit values are displayed in white (not bold).

The results displayed in this table are for the entire measurement. A specific number of bursts have been requested which requires more than one sweep then the results summary update at the end of each sweep showing the results so far. The number of bursts measured and the number of bursts requested are displayed to show the progress through the measurement.

General Settings

This section of the user manual describes the General Settings view where all settings related to the overall measurement can be modified, that is the Signal Characteristics, Data Capture, Trigger and IQ settings.

The *GENERAL SETTINGS* softkey brings up the General Settings view.

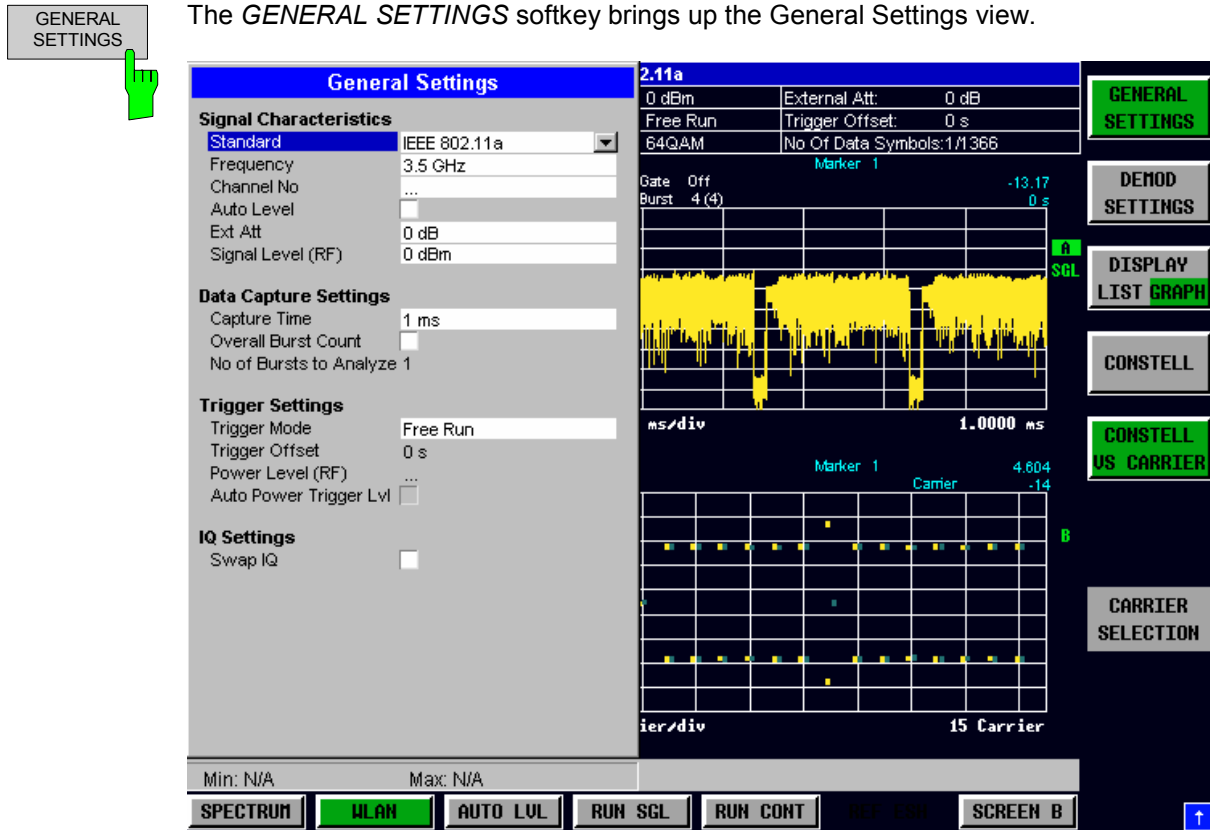

Fig. 2-10 General Settings view

The parameters within the General settings view are logically grouped together into:

- Signal Characteristics
- Data Capture Settings
- Trigger Settings
- IQ Settings

Any parameters that are not available for editing will have a grey background. This usually occurs when one parameter setting makes another parameter invalid, for example if the *Trigger Mode* is Free Run then none of the parameters below this (*Trigger Offset*, *Power Level* and *Auto Power Trigger Level*) have any meaning, so these parameters are greyed out.

When a particular parameter is selected within the General Settings view the status bar changes to display information about the valid settings for the selected parameter.

Signal Characteristics

The Signal Characteristics settings are the general settings concerning the level, attenuation and frequency of the signal to be measured.

Standard

Signal Characteristics	
Standard	IEEE 802.11a
Frequency	5.05 GHz
Channel No	10
Auto Level	<input checked="" type="checkbox"/>
Ext Att	0 dB
Signal Level (RF)	-30 dBm

Standard is used to select the wireless LAN standard to be measured against. This is necessary to ensure that the measurements are performed according to the specified standard with the correct limit values and limit lines.

This parameter provides a list of settings. The list provided depends on the standards which have been installed.

Frequency

Signal Characteristics	
Standard	IEEE 802.11a
Frequency	5.05 GHz
Channel No	10
Auto Level	<input checked="" type="checkbox"/>
Ext Att	0 dB
Signal Level (RF)	-30 dBm

Frequency specifies the Center Frequency of the signal to be measured.

When the *Frequency* is modified the *Channel No* parameter is updated accordingly.

The *Frequency* parameter is not editable when Base band input is selected because *Frequency* only make sense for a RF signal.

Channel No

Signal Characteristics	
Standard	IEEE 802.11a
Frequency	5.05 GHz
Channel No	10
Auto Level	<input checked="" type="checkbox"/>
Ext Att	0 dB
Signal Level (RF)	-30 dBm

Channel No specifies the channel to be measured.

When the *Channel No* is modified the *Frequency* parameter is updated accordingly.

The *Channel No* parameter is not editable when Base band input is selected because *Channel No* only make sense for a RF signal.

Auto Level

Signal Characteristics	
Standard	IEEE 802.11a
Frequency	5.05 GHz
Channel No	10
Auto Level	<input checked="" type="checkbox"/>
Ext Att	0 dB
Signal Level (RF)	-30 dBm

Auto Level selects whether the reference level for measurements is measured automatically (ON) or entered manually by the user (OFF).

When *Auto Level* is set to ON, FSP-K90 will measure the reference level automatically at the start of each measurement sweep. This ensures that the reference level is always set at the optimal level for obtaining accurate results but will result in slightly increased measurement times.

Ext Att

Signal Characteristics	
Standard	IEEE 802.11a
Frequency	5.05 GHz
Channel No	10
Auto Level	<input checked="" type="checkbox"/>
Ext Att	0 dB
Signal Level (RF)	-30 dBm

Ext Att specifies the external attenuation or gain applied to the RF signal. A positive value indicates attenuation, a negative value indicates gain.

All displayed power level values will be shifted by this value.

Signal Level (RF)

Signal Characteristics	
Standard	IEEE 802.11 a
Frequency	5.05 GHz
Channel No	10
Auto Level	<input checked="" type="checkbox"/>
Ext. Att	0 dB
Signal Level (RF)	-30 dBm

Signal Level (RF) specifies the expected level of the RF input signal.

The *Signal Level (RF)* is updated after an automatic level detection measurement has been executed when RF input is selected.

The *Signal Level (RF)* parameter is not editable when Base band input is selected because *Signal Level (RF)* only make sense for an RF signal.

Data Capture Settings

The Data Capture settings specify how much data is to be captured and measured.

Capture Time

Data Capture Settings	
Capture Time	1 ms
Overall Burst Count	<input checked="" type="checkbox"/>
No of Bursts to Analyze	1

Capture Time specifies the time (and therefore the amount of data) to be captured in a single measurement sweep.

Overall Burst Count

Data Capture Settings	
Capture Time	1 ms
Overall Burst Count	<input checked="" type="checkbox"/>
No of Bursts to Analyze	1

Overall Burst Count specifies whether a specified number of bursts are to be captured and analyzed.

When *Overall Burst Count* is set to OFF then data analysis shall be performed on a single measurement sweep . When *Overall Burst Count* is set to ON then data analysis may be performed over a number of consecutive sweeps until the required number of bursts has been captured and analyzed.

No of Burst to Analyze

Data Capture Settings	
Capture Time	1 ms
Overall Burst Count	<input checked="" type="checkbox"/>
No of Bursts to Analyze	1

No of Burst to Analyze specifies the number of bursts to be measured.

If the number of bursts of the specified type are not contained in a single measurement sweep then FSP-K90 will continue to perform measurement sweeps until the requested number of bursts of the specified type have been captured.

The *No of Burst to Analyze* parameter is not editable when *Overall Burst Count* is set to OFF.

Trigger Settings

The Trigger settings contains all the settings related to the triggering of a measurement sweep.

Trigger Mode

Trigger Settings	
Trigger Mode	Power
Trigger Offset	0 s
Power Level (RF)	0 dBm
Auto Power Trigger Lvl	<input checked="" type="checkbox"/>

Trigger Mode is the source of the trigger for the measurement sweep.

The possible values for the *Trigger Mode* are:

- Free Run** – the measurement sweep starts immediately.
- External** - triggering via a TTL signal at the input connector *EXT TRIGGER/GATE* on the rear panel.
- Power** - the measurement sweep starts when the signal power meets or exceeds the specified power trigger level.

Trigger Offset

Trigger Settings	
Trigger Mode	Power
Trigger Offset	0 s
Power Level (RF)	0 dBm
Auto Power Trigger Lvl	<input checked="" type="checkbox"/>

Trigger Offset specifies the time offset between the trigger signal and the start of the sweep. A negative value indicates a pre-trigger.

The *Trigger Offset* parameter is not editable when *Trigger Mode* is set to Free Run because this indicates that the measurement sweep should trigger immediately and as such a trigger delay or pre-trigger would not be appropriate.

Power Level (RF)

Trigger Settings	
Trigger Mode	Power
Trigger Offset	0 s
Power Level (RF)	0 dBm
Auto Power Trigger Lvl	<input checked="" type="checkbox"/>

Power Level (RF) Specifies the trigger level when a power trigger is selected and RF input is selected

The *Power Level* parameter is editable only when *Trigger Mode* is set to Power.

Auto Power Trigger Level

Trigger Settings	
Trigger Mode	Power
Trigger Offset	0 s
Power Level (RF)	0 dBm
Auto Power Trigger Level	<input checked="" type="checkbox"/>

Auto Power Trigger Level selects whether the level for the power trigger is measured automatically (ON) or entered manually by the user (OFF).

When *Auto Power Trigger Level* is set to ON, FSP-K90 will measure and determine the power trigger level automatically at the start of each measurement sweep. This ensures that the power trigger level is always set at the optimal level for obtaining accurate results but will result in a slightly increased measurement times.

The *Auto Power Trigger Level* parameter is editable only when *Trigger Mode* is set to Power.

IQ Settings

The IQ settings contains settings related the Inphase and Quadrature phase of the input signal.

Swap IQ

I Q Settings	
Swap IQ	<input type="checkbox"/>

Swap IQ allows selection between normal and inverted I/Q modulation. The settings for this parameter are:

- OFF Normal I/Q modulation.
- ON I and Q signals are interchanged.

Demod Settings

This section of the user manual describes the Demod (Short for Demodulation) Settings view where the settings associated with the signal modulation can be modified.

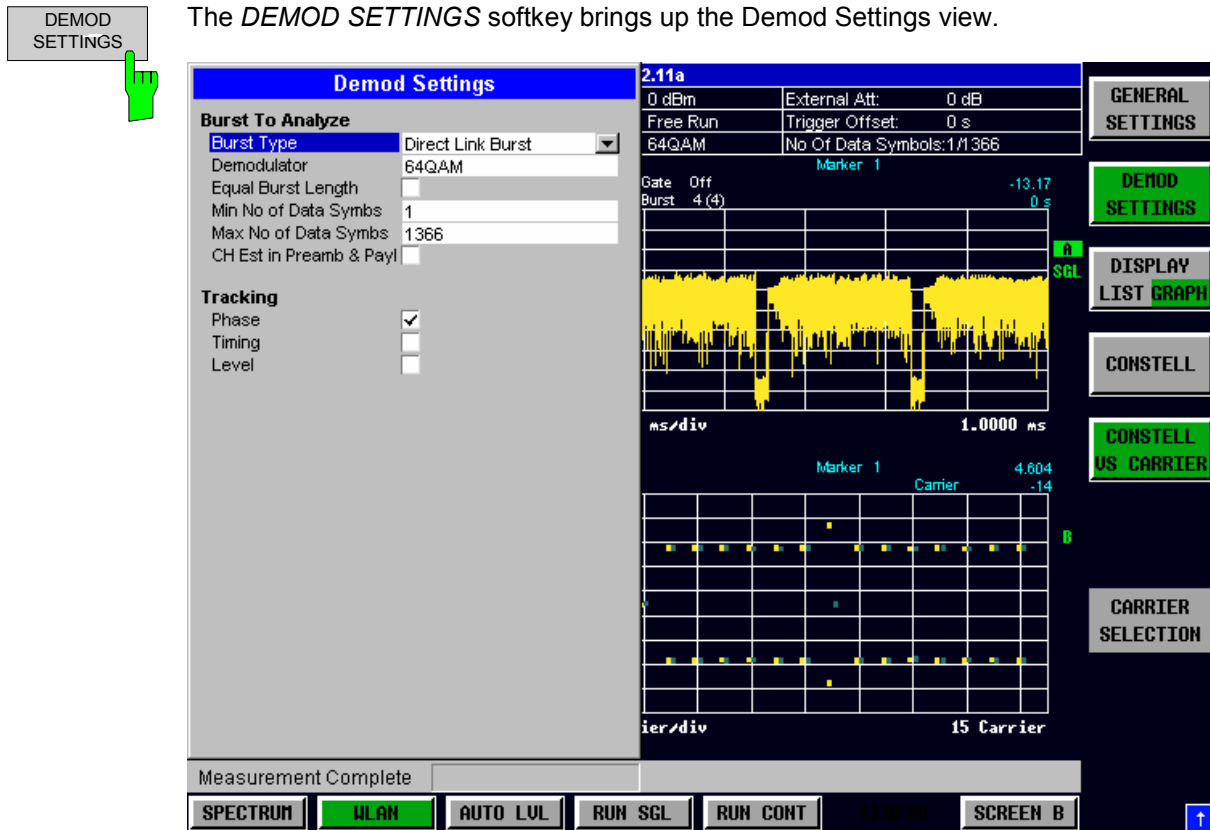

Fig. 2-11 Demod Settings view

The Demod settings are logically grouped together into:

- Burst to analyze settings
- Tracking settings

When a particular parameter is selected within the Demod Settings view the status bar changes to display information about the valid settings for the selected parameter.

Burst To Analyze Settings

The burst to analyze settings specify the characteristics of the bursts to be considered in the measurement results. Only those burst which meet the criteria specified in this group will be included in measurement analysis.

Burst Type

Burst To Analyze	
Burst Type	Direct Link Burst
Demodulator	64QAM
Equal Burst Length	<input type="checkbox"/>
Min No of Data Syms	1
Max No of Data Syms	1366
CH Est in Preamb & Payl	<input type="checkbox"/>

Burst Type specifies the type of burst which should be included in measurement analysis. Only one burst type can be selected for measurement results.

The settings for this parameter depend on which wireless LAN standard has been set for the *Standard* parameter in the General Settings view.

Demodulator

Burst To Analyze	
Burst Type	Direct Link Burst
Demodulator	64QAM
Equal Burst Length	<input type="checkbox"/>
Min No of Data Syms	1
Max No of Data Syms	1366
CH Est in Preamb & Payl	<input type="checkbox"/>

Demodulator is used to specify the modulation to be applied to the measured data. If the captured data uses a different modulation scheme than that specified by this parameter then the results will be of limited use.

The settings for this parameter depend on which wireless LAN standard has been set for the *Standard* parameter in the General Settings view.

Demodulator is only available when *Use Signal Symbol Field Content* is set to OFF

Equal Burst Length

Burst To Analyze	
Burst Type	Direct Link Burst
Demodulator	64QAM
Equal Burst Length	<input type="checkbox"/>
Min No of Data Syms	1
Max No of Data Syms	1366
CH Est in Preamb & Payl	<input type="checkbox"/>

Equal Burst Length allows burst with a range of data symbols or bursts with a specific number of data symbols to be selected for measurement analysis.

When *Equal Burst Length* is set to ON then the next parameter in the group becomes *No of Data Symbols* and only burst with exactly the number of symbols specified in *No of Data Symbols* are considered for measurement analysis.

When *Equal Burst Length* is set to OFF then the next parameter in the group becomes *Min No of Data Symbols* and bursts with a number of data symbols within the range specified by the *Min No of Data Symbols* and *Max No of Data Symbols* parameters take part in measurement analysis.

No of Data Symbols

Burst To Analyze	
Burst Type	Direct Link Burst
Demodulator	64QAM
Equal Burst Length	<input checked="" type="checkbox"/>
No of Data Symbols	1
Max No of Data Syms	1366
CH Est in Preamb & Payl	<input type="checkbox"/>

No of Data Symbols specifies the number of data symbols a burst must have for it to be considered in measurement analysis.

No of Data Symbols is only available when *Equal Burst Length* is set to ON.

Min No of Data Symbols

Burst To Analyze	
Burst Type	Direct Link Burst
Demodulator	64QAM
Equal Burst Length	<input type="checkbox"/>
Min No of Data Syms	1
Max No of Data Syms	1366
CH Est in Preamb & Payl	<input type="checkbox"/>

Min No of Data Symbols specifies the minimum number of data symbols a burst must have for it to be considered in measurement analysis.

Min No of Data Symbols is only available when *Equal Burst Length* is set to OFF.

Max No of Data Symbols

Burst To Analyze	
Burst Type	Direct Link Burst
Demodulator	64QAM
Equal Burst Length	<input type="checkbox"/>
Min No of Data Syms	1
Max No of Data Syms	1366
CH Est in Preamb & Payl	<input type="checkbox"/>

Max No of Data Symbols specifies the maximum number of data symbols a burst must have for it to be considered in measurement analysis.

Max No of Data Symbols is only available when *Equal Burst Length* is set to OFF.

Chan Est in Preamb and Payl

Burst To Analyze	
Burst Type	Direct Link Burst
Demodulator	64QAM
Equal Burst Length	<input type="checkbox"/>
Min No of Data Syms	1
Max No of Data Syms	1366
CH Est in Preamb & Payl	<input type="checkbox"/>

Chan Est in Preamb and Payl specifies how accurately the EVM results should be calculated.

When *Chan Est in Preamb and Payl* is set to OFF then the EVM results are calculated in accordance with the selected standard. In this case channel estimation is done in the the preamble only.

When *Chan Est in Preamb and Payl* is set to ON then the EVM results are calculated more accurately. In this case channel estimation is done in both preamble and payload.

Tracking Settings

The tracking settings allow various errors in measurement results to be compensated for.

Phase

Tracking	
Phase	<input checked="" type="checkbox"/>
Timing	<input checked="" type="checkbox"/>
Level	<input checked="" type="checkbox"/>

Phase is used to specify whether or not the measurement results should be compensated for phase error.

When *Phase* is set to ON then the measurement results will be compensated for phase error on a per-symbol basis.

Timing

Tracking	
Phase	<input checked="" type="checkbox"/>
Timing	<input checked="" type="checkbox"/>
Level	<input checked="" type="checkbox"/>

Timing is used to specify whether or not the measurement results should be compensated for timing error.

When *Timing* is set to ON then the measurement results will be compensated for timing error on a per-symbol basis.

Level

Tracking	
Phase	<input checked="" type="checkbox"/>
Timing	<input checked="" type="checkbox"/>
Level	<input checked="" type="checkbox"/>

Level is used to specify whether or not the measurement results should be compensated for level error.

When *Level* is set to ON then the measurement results will be compensated for level error on a per-symbol basis.

Markers

This section of the user manual describes the Marker facility of the option.

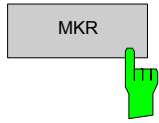

The *MKR* hardkey brings up the marker softkey menu. Any settings views on display when the marker softkey menu is displayed shall be closed.

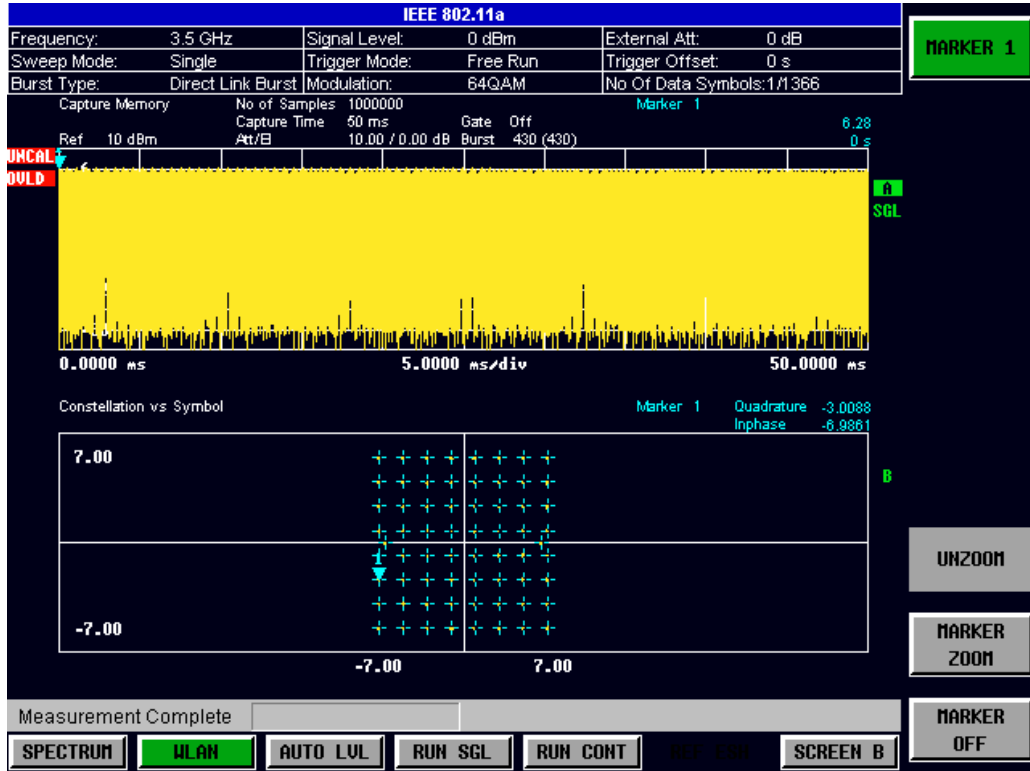
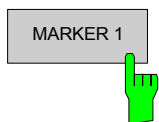

Fig. 2-12 Marker Menu

From the marker menu it is possible to adjust the marker position, use the marker to zoom in & out and switch the marker display off.

Adjusting Markers

The marker can be adjusted by pressing the marker softkey in the marker softkey menu



The *MARKER* softkey displays the Marker pop-up dialog. The contents of the marker pop-up depends on the type of graph to which the marker being adjusted belongs.

As soon as an field in the marker pop-up dialog is adjusted then the marker position in the trace will update, along with the results displayed for the marker.

Marker Zoom

A zoom facility is available for markers belonging to the following result traces:

- Magnitude Capture
- Constellation Vs Symbol
- Constellation Vs Carrier

A rectangular softkey with a grey background and the text "MARKER ZOOM" in black.

The *MARKER ZOOM* softkey displays the Marker Zoom pop-up dialog which contains the magnification factor for the zoom.

The maximum magnification depends on the type of results trace.

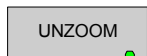
A rectangular softkey with a grey background and the text "UNZOOM" in black.

The *UNZOOM* softkey cancels the marker zoom.

Toggle Marker Display

Markers can be toggled by pressing the Marker soft-key as follows:

A rectangular softkey with a grey background and the text "MARKER 1" in black.

Pressing the *MARKER* softkey when the marker is not displayed (softkey has grey background) causes the Marker pop-up to be displayed and the marker to be switched on.

A rectangular softkey with a red background and the text "MARKER 1" in black.

Pressing the *MARKER* softkey when the Marker pop-up is displayed (softkey has red background) causes the marker to be switched off.

A rectangular softkey with a green background and the text "MARKER 1" in black.

Pressing the *MARKER* softkey when the Marker is displayed but the Marker pop-up is not displayed (softkey has green background) causes the Marker pop-up to be displayed.

All markers in the active screen can be switched off by pressing the *MARKER OFF* softkey

Assigning Markers to Traces

In result graphs which have more than one trace (e.g. EVM vs. Symbol) the marker can be assigned to any of the displayed traces

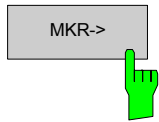

Pressing the *MKR->* hardkey displays the Marker Extension softkey menu.

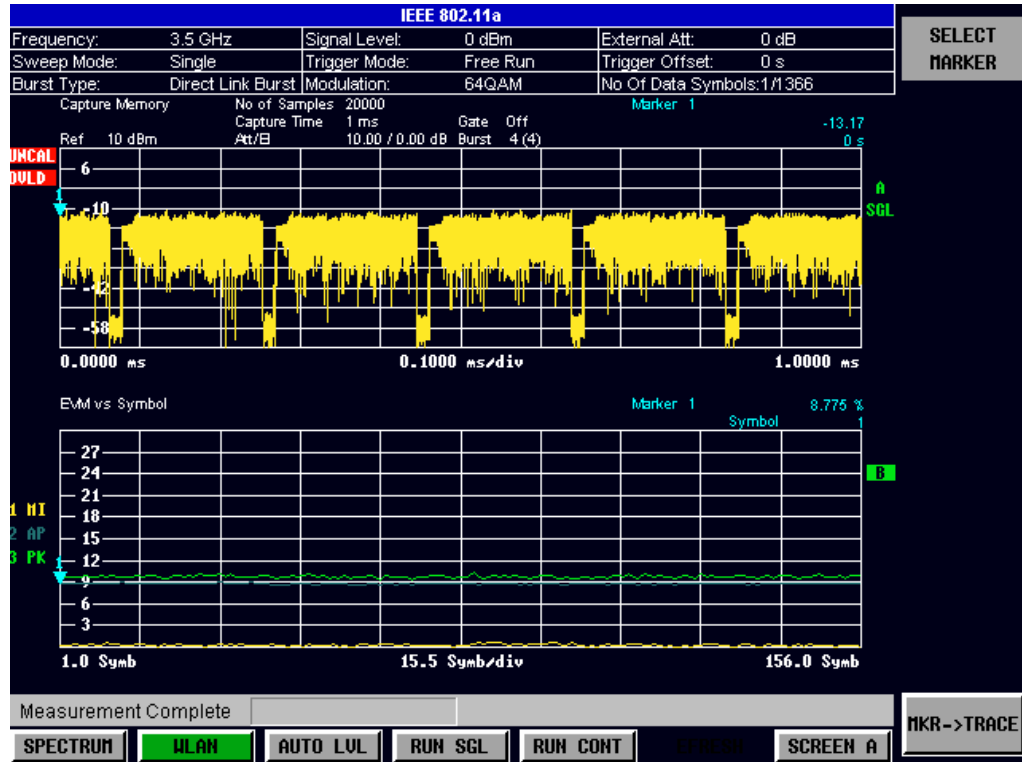
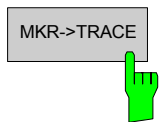

Fig. 2-13 Marker Extension Softkey Menu



Pressing the *MKR->TRACE* displays the Select Trace pop-up dialog. This allows the ID of the trace to which the marker is to be attached to be supplied.

Display Settings

The layout of the display can be controlled using the display menu

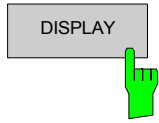

The *DISPLAY* hardkey brings up the display softkey menu. Any settings views on display when the display softkey menu is displayed shall be closed.

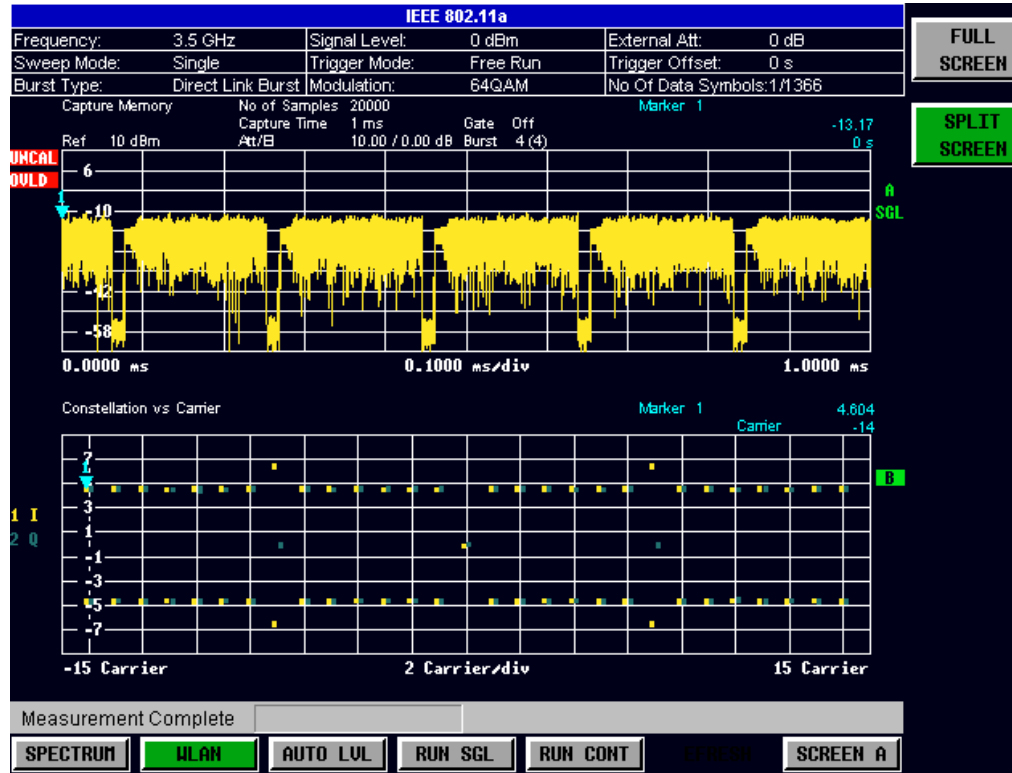

Fig. 2-14 Display Menu

The display menu allows the display to be changed between split and full screen display for IQ measurement results. Note that for frequency sweep measurement results (Spectrum Mask and Spectrum ACPR) the display is always full screen.

The active screen can be selected by pressing the *SCREEN A/SCREEN B* hotkey. A screen needs to be made active in order to control the markers it displays.

In full screen mode the *SCREEN A/SCREEN B* hotkey also toggles which screen is displayed.

3 Measurements in Detail

This section provides a more detailed explanation of the measurements provided by FSP-K90 and provides help for using FSP-K90 to measure the characteristics of specific types of DUT.

Abbreviations

$a_{l,k}$	symbol at symbol l of subcarrier k
EVM_k	error vector magnitude of subcarrier k
EVM	error vector magnitude of current packet
g	signal gain
Δf	frequency deviation between Tx and Rx
l	symbol index $l = [1, \text{nof_Symbols}]$
nof_symbols	number of symbols of payload
H_k	channel transfer function of subcarrier k
k	channel index $k = [-31, 32]$
K_{mod}	modulation dependant normalization factor
ξ	relative clock error of reference oscillator
$r_{l,k}$	subcarrier k of symbol l

Signal Processing of the IEEE802.11a application

This description gives a rough view of the IEEE802.11a application signal processing. Details are disregarded in order to get a concept overview.

A diagram of the interesting blocks is shown in figure 1. First the RF signal is downconverted to the IF frequency $f_{IF} = 20.4$ MHz. The resulting IF signal $r_{IF}(t)$ is shown on the left-hand side of the figure. After bandpass filtering, the signal is sampled by an Analog to Digital Converter (ADC) at a sampling rate of $f_{s1} = 81.6$ MHz. This digital sequence is resampled to the new sampling frequency of $f_{s2} = 80$ MHz which is a multiple of the Nyquist rate (20 MHz). The subsequent digital downconverter shifts the IF signal to the complex base band. In the next step the base band signal is filtered by a FIR filter. To get an idea, the rough transfer function is plotted in the figure. This filter fulfills two tasks: first it suppresses the IF image frequency, secondly it attenuates the aliasing frequency bands caused by the subsequent downsampling. After filtering, the sequence is sampled down by the factor of 4. Thus the sampling rate of the downsampled sequence $r(i)$ is the Nyquist rate of $f_{s3} = 20$ MHz. Up to this point the digital part is implemented in an ASIC.

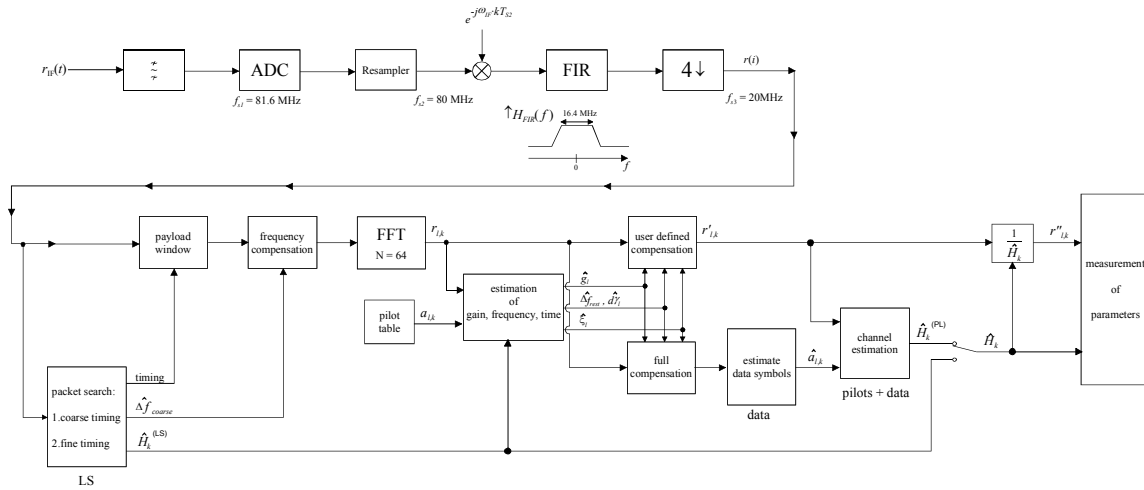

Fig. 3-1

In the lower part of the figure the subsequent digital signal processing is shown. In the first block the packet search is performed. This block detects the Long Symbol (LS) and recovers the timing. The coarse timing is detected first. This search is implemented in the time domain. The algorithm is based on cyclic repetition within the LS after $N = 64$ samples. Numerous treatises exist on this subject, e.g. [1]-[3]. Furthermore a coarse estimate $\hat{\Delta f}_{coarse}^1$ of the Rx-Tx frequency offset Δf is derived from the metric in [6]. This can easily be understood because the phase of $r(i) \cdot r^*(i + N)$ is determined by the frequency offset. As the frequency deviation Δf can exceed half a bin (distance between neighbor sub-carriers) the preceding Short Symbol (SS) is also analyzed in order to detect the ambiguity. After the coarse timing calculation the time estimate is improved by the fine timing calculation. This is achieved by first estimating the coarse frequency response $\hat{H}_k^{(LS)}$, with $k = [-26, 26]$ denoting the channel index of the occupied sub-carriers. First the FFT of the LS is calculated. After the FFT calculation the known symbol information of the LS sub-carriers is removed by dividing by the symbols. The result is a coarse estimate \hat{H}_k of the channel transfer function. In the next step the complex channel impulse response is computed by an IFFT. Next the energy of the windowed impulse response (the window size is equal to the guard period) is calculated for every trial time. Afterwards the trail time of the maximum energy is detected. This trial time is used to adjust the timing.

Now the position of the LS is known and the starting point of the useful part of the first payload symbol can be derived. In the next block this calculated time instant is used to position the payload window. Only the payload part is windowed. This is sufficient because the payload is the only subject of the subsequent measurements.

In the next block the windowed sequence is compensated by the coarse frequency estimate $\hat{\Delta f}_{coarse}$. This is necessary because otherwise inter channel interference (ICI) would occur in the frequency domain.

The transition to the frequency domain is achieved by an FFT of length 64. The FFT is performed symbol-wise for every of the *nof_symbols* symbols of the payload. The calculated FFTs are described by $r_{l,k}$ with

- the symbol index $l = [1, nof_symbols]$ and
- the channel index $k = [-31, 32]$.

In case of an additive white Gaussian noise (AWGN) channel the FFT is described by [4], [5]

$$r_{l,k} = K_{mod} \cdot a_{l,k} \cdot g_l \cdot H_k \cdot e^{j(\text{phase}_l^{(commom)} + \text{phase}_l^{(timing)})} + n_{l,k} \quad (1)$$

¹ In this paper the hat generally describes an estimate. Example: \hat{x} is the estimate of x .

with

- the modulation-dependant normalization factor K_{mod} ,
- the symbol $a_{l,k}$ of sub-carrier k at symbol l ,
- the gain g_l at the symbol l in relation to the reference gain $g = 1$ at the long symbol (LS),
- the channel frequency response H_k at the long symbol (LS),
- the common phase drift $\text{phase}_l^{(\text{common})}$ of all sub-carriers at symbol l (see below),
- the phase $\text{phase}_{l,k}^{(\text{timing})}$ of sub-carrier k at symbol l caused by the timing drift (see below),
- the independent Gaussian distributed noise samples $n_{l,k}$.

The common phase drift in equation (1) is given by

$$\text{phase}_l^{(\text{common})} = 2\pi \cdot N_s / N \cdot \Delta f_{\text{rest}} \cdot T \cdot l + d\gamma_l \quad (2)$$

with

- $N_s = 80$ being the number of Nyquist samples of the symbol period,
- $N = 64$ being the number of Nyquist samples $N = 64$ of the useful part of the symbol,
- Δf_{rest} being the (not yet compensated) frequency deviation,
- $d\gamma_l$ being the phase jitter at the symbol l .

In general, the coarse frequency estimate $\hat{\Delta f}_{\text{coarse}}$ (see figure 1) is not error-free. Therefore the remaining frequency error Δf_{rest} represents the not yet compensated frequency deviation in $r_{l,k}$. Consequently the overall frequency deviation of the device under test (DUT) is calculated by $\Delta f = \hat{\Delta f}_{\text{coarse}} + \Delta f_{\text{rest}}$. Remark: The only motivation for dividing the common phase drift in equation (2) into two parts is to be able to calculate the overall frequency deviation of the DUT.

The reason for the phase jitter $d\gamma_l$ in equation (2) may be different. The nonlinear part of the phase jitter may be caused by the phase noise of the DUT oscillator. Another reason for nonlinear phase jitter may be the increase of the DUT amplifier temperature at the beginning of the burst. Please note that besides the nonlinear part the phase jitter $d\gamma_l$ also contains a constant part. This constant part is caused by the not yet compensated frequency deviation Δf_{rest} . To understand this, please keep in mind that the measurement of the phase starts at the first symbol $l = 1$ of the payload. In contrast the channel frequency response H_k in equation (1) represents the channel at the long symbol of the preamble. Consequently the not yet compensated frequency deviation Δf_{rest} produces a phase drift between the long symbol and the first symbol of the payload. Therefore this phase drift appears as a constant value (“DC value”) in $d\gamma_l$.

Referring to the IEEE802.11a measurement standard *Chapter 17.3.9.7 “Transmit modulation accuracy test”* [6], the common phase drift $\text{phase}_l^{(\text{common})}$ must be estimated and compensated from the pilots. Therefore this “symbol wise phase tracking” (Tracking Phase) is activated as the default setting of the FSP-K90.

Furthermore the timing drift in equation (1) is given by

$$\text{phase}_{l,k}^{(\text{timing})} = 2\pi \cdot N_s / N \cdot \xi \cdot k \cdot l \quad (3)$$

with ξ being the relative clock deviation of the reference oscillator. Normally a symbol-wise timing jitter is negligible and thus not modelled in equation (3). There may be situations where the timing drift has to be taken into account. This is illustrated by an example: In accordance to [6] the allowed clock deviation of the DUT is up to $\xi_{\max} = 20$ ppm. Furthermore a long packet with $nof_symbols = 400$ symbols is assumed. From equations (1) and (3), it results that the phase drift of the highest sub-carrier $k = 26$ in the last symbol $l = nof_symbols$ is 93 degrees. Even in the noise-free case, this would lead to symbol errors. The example shows that it is actually necessary to estimate and compensate the clock deviation, which is accomplished in the next block.

Referring to the IEEE802.11a measurement standard [6], the timing drift $phase_{l,k}^{(timing)}$ is not part of the requirements. Therefore the “time tracking” (Tracking Time) is not activated as the default setting of the FSP-K90.

The time tracking option should rather be seen as a powerful analysing option.

In addition the tracking of the gain g_l in equation (1) is supported for each symbol in relation to the reference gain $g = 1$ at the time instant of the long symbol (LS). At this time the coarse channel transfer function $\hat{H}_k^{(LS)}$ is calculated. This makes sense since the sequence $r_{l,k}^1$ is compensated by the coarse channel transfer function $\hat{H}_k^{(LS)}$ before estimating the symbols. Consequently a potential change of the gain at the symbol l (caused, for example, by the increase of the DUT amplifier temperature) may lead to symbol errors especially for a large symbol alphabet M of the MQAM transmission. In this case the estimation and the subsequent compensation of the gain is useful.

Referring to the IEEE802.11a measurement standard [6], the compensation of the gain g_l is not part of the requirements. Therefore the “gain tracking” (Tracking Gain) is not activated as the default setting of the FSP-K90.

How can the parameters above be calculated? In this application the optimum maximum likelihood algorithm is used. In the first estimation step the symbol-independent parameters Δf_{rest} and ξ are estimated. The symbol dependent parameters can be neglected in this step i.e. the parameters are set to $g_l = 1$ and $d\gamma_l = 0$. Referring to equation (1) the log likelihood function²

$$L_1(\tilde{\Delta f}_{rest}, \tilde{\xi}) \stackrel{\text{eq.(1)}}{=} \sum_{l=1}^{nof_symbols} \sum_{k=-21, -7, 7, 21} \left| r_{l,k} - a_{l,k} \cdot \hat{H}_k^{(LS)} \cdot e^{j(\tilde{p}hase_l^{(common)} + \tilde{p}hase_{l,k}^{(timing)})} \right|^2$$

with

$$\tilde{p}hase_l^{(common)} \stackrel{\text{eq.(2)}}{=} 2\pi \cdot N_s / N \cdot \tilde{\Delta f}_{rest} \cdot T \cdot l$$

$$\tilde{p}hase_l^{(timing)} \stackrel{\text{eq.(3)}}{=} 2\pi \cdot N_s / N \cdot \tilde{\xi} \cdot k \cdot l \quad (4)$$

must be calculated as a function of the trial parameters $\tilde{\Delta f}_{rest}$ and $\tilde{\xi}$. The trial parameters leading to the minimum of the log likelihood function are used as estimates $\hat{\Delta f}_{rest}$ and $\hat{\xi}$. In equation (4) the known pilot symbols $a_{l,k}$ are read from a table.

In the second step for every symbol l the log likelihood function

$$L_2(\tilde{g}_l, d\tilde{\gamma}_l) \stackrel{\text{eq.(1)}}{=} \sum_{k=-21, -7, 7, 21} \left| r_{l,k} - a_{l,k} \cdot \tilde{g}_l \cdot \hat{H}_k^{(LS)} \cdot e^{j(\tilde{p}hase_l^{(common)} + \tilde{p}hase_{l,k}^{(timing)})} \right|^2$$

with

$$\tilde{p}hase_l^{(common)} \stackrel{\text{eq.(2)}}{=} 2\pi \cdot N_s / N \cdot \hat{\Delta f}_{rest} \cdot T \cdot l + d\tilde{\gamma}_l$$

$$\hat{p}hase_l^{(timing)} \stackrel{\text{eq.(3)}}{=} 2\pi \cdot N_s / N \cdot \hat{\xi} \cdot k \cdot l$$

² In this paper the tilde generally describes an estimate. Example: \tilde{X} is the trial parameter of X .

is calculated as a function of the trial parameters \tilde{g}_l and $d\tilde{\gamma}_l$. Finally, the trial parameters leading to the minimum of the log likelihood function are used as estimates \hat{g}_l and $d\hat{\gamma}_l$.

This robust algorithm works well even at low signal to noise ratios with the Cramer Rao Bound being reached.

After estimation of the parameters, the sequence $r_{l,k}$ is compensated in the compensation blocks. In the upper analysing branch the compensation is user-defined i.e. the user determines which of the parameters are compensated. This is useful in order to extract the influence of these parameters. The resulting output sequence is described by $r'_{l,k}$.

In the lower compensation branch the full compensation is always performed. This separate compensation is necessary in order to avoid symbol errors. After the full compensation the secure estimation of the data symbols $\hat{a}_{l,k}$ is performed. From equation (1) it is clear that first the channel transfer function H_k must be removed. This is achieved by dividing the known coarse channel estimate $\hat{H}_k^{(LS)}$ calculated from the LS. Usually an error free estimation of the data symbols can be assumed.

In the next block a better channel estimate $\hat{H}_k^{(PL)}$ of the data and pilot sub-carriers is calculated by using all *nof_symbols* symbols of the payload (PL). This can be accomplished at this point because the phase is compensated and the data symbols are known. The long observation interval of *nof_symbols* symbols (compared to the short interval of 2 symbols for the estimation of $\hat{H}_k^{(LS)}$) leads to a nearly error-free channel estimate.

In the following equalizer block $r'_{l,k}$ is compensated by the channel estimate. The resulting channel-compensated sequence is described by $r''_{l,k}$. The user may either choose the coarse channel estimate $\hat{H}_k^{(LS)}$ (from the long symbol) or the nearly error-free channel estimate $\hat{H}_k^{(LS)}$ (from the payload) for equalization. In case of using the improved estimate $\hat{H}_k^{(LS)}$ a 2 dB reduction of the subsequent EVM measurement can be expected.

According to the IEEE802.11a measurement standard [6], the coarse channel estimation $\hat{H}_k^{(LS)}$ (from the long symbol) has to be used for equalization. Therefore the default setting of the FSP-K90 is equalization from the coarse channel estimate derived from the long symbol.

In the last block the measurement variables are calculated. The most important variable is the error vector magnitude

$$EVM_k = \sqrt{\frac{1}{nof_Symbols} \cdot \sum_{l=1}^{nof_Symbols} |r''_{l,k} - K_{mod} \cdot a_{l,k}|^2} \quad (5)$$

of the sub-carrier k of the current packet. Furthermore the packet error vector magnitude

$$EVM = \sqrt{\frac{1}{52} \cdot \sum_{\substack{k=-26 \\ (k \neq 0)}}^{26} EVM_k^2} \quad (6)$$

is derived by averaging the squared EVM_k versus k . Finally the average error vector magnitude

$$\overline{EVM} = \sqrt{\frac{1}{nof_packets} \sum_{counter=1}^{nof_packets} EVM^2(counter)} \quad (7)$$

is calculated by averaging the packet EVM of all *nof_packets* detected packets. This parameter is equivalent to the so-called "RMS average of all errors $Error_{RMS}$ " of the IEEE802.11a measurement commandment (see [6], Chapter 17.3.9.7).

4 Remote Control

Description of commands

This section specifies all the remote control commands specific to the FSP-K90 option. Only those commands provided for this option are specified. For details of remote control commands provided by the host analyzer please refer to the analyzer user manual.

Notation

In the following sections, all commands implemented in the instrument are first listed in tables and then described in detail, arranged according to the command subsystems. The notation is adapted to the SCPI standard. The SCPI conformity information is included in the individual description of the commands.

Table of Commands

Command:	In the command column, the table provides an overview of the commands and their hierarchical arrangement (see indentations).
Parameter:	The parameter column indicates the requested parameters together with their specified range.
Unit:	The unit column indicates the basic unit of the physical parameters.
Comment:	In the comment column an indication is made on: <ul style="list-style-type: none"> – whether the command does not have a query form, – whether the command has only one query form – whether the command is implemented only with a certain option of the instrument

Indentations

The different levels of the SCPI command hierarchy are represented in the table by means of indentations to the right. The lower the level, the further the indentation to the right. Please note that the complete notation of the command always includes the higher levels as well.

Example: `SENSe:FREQuency:CENTer` is represented in the table as follows:

SENSe	first level
:FREQuency	second level
:CENTer	third level

Individual description

The individual description contains the complete notation of the command. An example for each command, the *RST value and the SCPI information are included as well.

Upper/lower case notation

Upper/lower case letters are used to mark the long or short form of the key words of a command in the description (see Section 3.5.2). The instrument itself does not distinguish between upper and lower case letters.

Special characters

A selection of key words with an identical effect exists for several commands. These keywords are indicated in the same line; they are separated by a vertical stroke. Only one of these keywords needs to be included in the header of the command. The effect of the command is independent of which of the keywords is used.

Example: `SENSe:FREQuency:CW|:FIXed`

The two following commands with identical meaning can be created. They set the frequency of the fixed frequency signal to 1kHz:

```
SENSe:FREQuency:CW 1E3 = SENSe:FREQuency:FIXed 1E3
```

A vertical stroke in parameter indications marks alternative possibilities in the sense of "or". The effect of the command is different, depending on which parameter is used.

Example: Selection of the parameters for the command

```
DISPlay:FORMat FULL | SPLit
```

If parameter FULL is selected, full screen is displayed, in the case of SPLit, split screen is displayed.

- [] Key words in square brackets can be omitted when composing the header (cf. Section 3.5.2, Optional Keywords). The full command length must be accepted by the instrument for reasons of compatibility with the SCPI standards. Parameters in square brackets can be incorporated optionally in the command or omitted as well.
- { } Parameters in braces can be incorporated optionally in the command, either not at all, once or several times.

Description of parameters

Due to the standardisation, the parameter section of SCPI commands consists always of the same syntactical elements. SCPI has therefore specified a series of definitions, which are used in the tables of commands. In the tables, these established definitions are indicated in angled brackets (<...>) and will be briefly explained in the following (see also Section 3.5.5, "Parameters").

<Boolean> This keyword refers to parameters which can adopt two states, "on" and "off". The "off" state may either be indicated by the keyword OFF or by the numeric value 0, the "on" state is indicated by ON or any numeric value other than zero. Parameter queries are always returned the numeric value 0 or 1.

<numeric_value>

<num> These keywords mark parameters which may be entered as numeric values or be set using specific keywords (character data). The following keywords given below are permitted:

MINimum This keyword sets the parameter to the smallest possible value.

MAXimum This keyword sets the parameter to the largest possible value.

DEFault This keyword is used to reset the parameter to its default value.

UP This keyword increments the parameter value.

DOWN This keyword decrements the parameter value. The numeric values associated to MAXimum/MINimum/DEFault can be queried by adding the corresponding keywords to the command. They must be entered following the quotation mark.

Example: SENSe:FREQuency:CENTer? MAXimum

returns the maximum possible numeric value of the center frequency as result.

<arbitrary block program data>

This keyword is provided for commands the parameters of which consist of a binary data block.

SCPI Commands

ABORt Subsystem

The ABORt subsystem provide a mechanism by which running measurements can be aborted

COMMAND	PARAMETERS	UNIT	COMMENT
ABORt			

ABORt

This causes the current measurement, which is being performed, to be aborted.

Example: "ABOR" - The FSP-K90 option will attempt to abort the current active measurement.

Characteristics: *RST value: --
SCPI: Conforming

Mode: K90

CALCulate: Subsystem

CALCulate:MARKer Subsystem

The CALCulate:MARKer subsystem checks the marker functions in the FSP-K90 option.

CALCulate 1: Screen A

CALCulate 2: Screen B

Note: Currently there is only 1 marker is available and it is always on.

COMMAND	PARAMETERS	UNIT	COMMENT
CALCulate<1 2>: MARKer<1> :TRACe :X :Y :SYMBol :CARRier :AOFF [:STATe]	<numeric_value> <numeric_value> <numeric_value> <numeric_value> <numeric_value> <Boolean>	HZ S DB PCT DB	

CALCulate<1|2>:MARKer<1>:TRACe

This command assigns the selected marker to the indicated measurement curve in the selected measurement window.

This command is only available for the following result displays:

Constellation versus Carrier

EVM versus Symbol

PVT Full Burst

PVT Rising / Falling

Example: "CALC2:MARK:TRAC 2" Assigns marker 1 in screen B to trace 2.
"CALC2:MARK:TRAC 5" Assigns marker 1 in screen B to trace 5.

Characteristics: *RST value: 1
SCPI: device-specific

Mode: K90

CALCulate<1|2>:MARKer<1>:X

This command positions the selected marker to the indicated inphase (constellation Vs symbol), frequency (spectrum FFT, spectrum mask), time (magnitude capture buffer, auto level, PVT full burst, PVT rising / falling), power (CCDF), sub-carrier (constellation Vs carrier, EVM Vs carrier, spectrum flatness) or symbol (EVM Vs symbol) in the selected measurement window.

This command is query only for the following result displays:

Constellation Vs Symbol

Constellation Vs Carrier

Example: "CALC:MARK:X 2ms" Positions marker 1 in screen A to time 2ms.

Characteristics: *RST value: -
SCPI: device-specific

Mode: K90

CALCulate<1|2>:MARKer<1>:Y

This command positions the selected marker to the indicated quadrature (constellation Vs symbol), magnitude of I or Q (constellation Vs carrier), EVM (EVM Vs carrier) or abs (spectrum flatness) in the selected measurement window.

This command is query only for the following result displays:

Auto level
 Constellation Vs Symbol
 Constellation Vs Carrier
 EVM Vs Symbol
 PVT Full
 PVT Rising / Falling
 Magnitude Capture Buffer
 Spectrum Mask
 Spectrum FFT
 CCDF

Example: "CALC2:MARK:Y -2" Positions marker 1 in screen B to -2.
 "CALC:MARK:Y?" Outputs the measured value of marker 1 in screen A.

Characteristics: *RST value: -
 SCPI: device-specific

Mode: K90

CALCulate<1|2>:MARKer<1>:SYMBol

This command positions the selected marker to the indicated symbol (constellation vs symbol and constellation Vs carrier).

This command is valid only for the following result displays:

constellation Vs symbol
 constellation Vs carrier

Example: "CALC2:MARK:SYMB 2" Positions marker 1 in screen B to symbol 2.
 "CALC2:MARK:SYMB?" Outputs the symbol value of marker 1 in screen B.

Characteristics: *RST value: -
 SCPI: device-specific

Mode: K90

CALCulate<1|2>:MARKer<1>:CARRier

This command positions the selected marker to the indicated carrier (constellation vs symbol and constellation Vs carrier).

This command is valid only for the following result displays:

constellation Vs symbol
 constellation Vs carrier

Example: "CALC2:MARK:CARR -7" Positions marker 1 in screen B to carrier -7.
 "CALC2:MARK:CARR?" Outputs the carrier value of marker 1 in screen B.

Characteristics: *RST value: -
 SCPI: device-specific

Mode: K90

CALCulate<1|2>:MARKer<1>:AOFF

This command switches off all active markers in the specified measurement window. The window will either be “screen a” or “screen b” and will be determined by the numeric value that follows the “CALCulate” keyword.

Example: "CALC1:MARK:AOFF" 'Switches off all markers in the screen A window.
"CALC2:MARK:AOFF" 'Switches off all markers in the screen B window.

Characteristics: *RST value: -
SCPI: device-specific

Mode: K90

CALCulate<1|2>:MARKer<1>:STATE

This command switches the markers on or off

Example: "CALC1:MARK1:STATE ON" Switches the screen A marker ON.
"CALC2:MARK1:STATE OFF" Switches the screen B marker OFF.

Characteristics: *RST value: 1
SCPI: device-specific

Mode: K90

CALCulate:MARKer:FUNction Subsystem

The measurement window is selected by CALCulate 1 (screen A) or 2 (screen B).

COMMAND	PARAMETERS	UNIT	COMMENT
CALCulate<1 2> :MARKer<1> :FUNction :ZOOM :POWer :RESult	<numeric_value>	DB	Query only

CALCulate<1|2>:MARKer<1>:FUNction:ZOOM

This command defines the ratio to be zoomed around the marker 1 in the selected measurement window. The default value is 1, where the full trace is shown.

This command is only available for the following result displays:

- Constellation versus Carrier
- Constellation versus Symbol
- PVT Full Burst
- PVT Rising / Falling
- Magnitude Capture Buffer

Example: "CALC:MARK:FUNC:ZOOM 2" Zooms 50% in screen A.
 "CALC:MARK:FUNC:ZOOM 4" Zooms 25% in screen A.
 "CALC:MARK:FUNC:ZOOM 1" Deactivates zooming in screen A.

Characteristics: *RST value: 1
 SCPI: device-specific

Mode: K90

CALCulate<1|2>:MARKer<1>:FUNction:POWer:RESult?

This command queries the results of the adjacent channel power measurement. An ACPR (Adjacent channel power relative) measurement must have previously been run, for there to be summary data available.

Results are output separated by commas in the following order:

1. Power of main channel
2. Power of lower adjacent channel
3. Power of upper adjacent channel
4. Power of lower alternate adjacent channel 1
5. Power of upper alternate adjacent channel 1
6. Power of lower alternate adjacent channel 2
7. Power of upper alternate adjacent channel 2

Adjacent channel power values are output in dB.

Example: "CALC2:MARK:FUNC:POW:RES?"

Characteristics: *RST value: -
 SCPI: device-specific

Mode: K90

Configure Subsystem

The CONFigure subsystem contains commands for configuring complex measurement tasks. The CONFigure subsystem is closely linked to the functions of the FETCh subsystem, where the measurement results of the measurements are queried.

COMMAND	PARAMETERS	UNIT	COMMENT
CONFigure			
:POWer			
:EXPEcted			
:RF	<numeric_value>	DBM	B71 Option Only
:IQ	<numeric_value>	V	
:AUTO	<boolean>		
:CHANnel	<numeric_value>		
:STANdard	<numeric_value>		
:BURSt			
:EVM			
:ECARrier			
[:IMMediate]			
:ESYMBOL			
[:IMMediate]			
:SPEctrum			
:MASK			
[:IMMediate]			
:ACPR			
[:IMMediate]			
:CONStellation			
:CCARrier			
[:IMMediate]			
:CSYMBOL			
[:IMMediate]			
:CARRier			
:SElect	-14 to 14 ALL PILOTS		

CONFigure:POWer:EXPEcted:RF

This remote control command is used to specify the mean power level of the source signal as supplied to the Analyzer RF input. This value will be overwritten if Auto Level is turned on.

Example: "CONF:POW:EXP:RF 9" The FS-K90 option assumes an input signal strength of 9 dBm

Characteristics: *RST value: -
SCPI: Device Specific

Mode: K90

CONFigure:POWer:EXPEcted:IQ

This remote control command is used to specify the mean power level of the source signal as supplied to the Analyzer IQ inputs. This value will be overwritten if Auto Level is turned on. Note that this command requires option B71.

Example: "CONF:POW:EXP:IQ 1" The FSP-K90 option assumes an input signal strength of 1 Volt

Characteristics: *RST value: -
SCPI: Device Specific

Mode: K90

CONFigure:POWER:AUtO

This remote control command is used to switch on or off automatic power level detection. When switched on, power level detection is performed at the start of each measurement sweep.

Example: “CONF:POW:AUTO 1” The FSP-K90 option will automatically detect the input power level

Characteristics: *RST value: -
SCPI: Device Specific

Mode: K90

CONFigure:CHANnel

This remote control command is used to specify the input channel for which measurements are to be performed. This command will automatically cause the internal measurement frequency to be recalculated.

Example: “CONF:CHAN 9” - The FSP-K90 option will perform measurements at the frequency represented by channel 9.

Characteristics: *RST value: 0
SCPI: Device Specific

Mode: K90

CONFigure:STANdard

This remote control command specifies which Wireless LAN standard the option is configured to measure. Currently only IEEE 802.11a is supported

Example: “CONF:STAN 1” - The FSP-K90 option will perform measurements According to IEEE 802.11a.

Characteristics: *RST value: 1
SCPI: Device Specific

Mode: K90

CONFigure:BURSt:EVM:ECARrier[:IMMediate]

This remote control command configures the FSP-K90 measurement type to be EVM Versus Carrier. After this command has been executed, the specified measurement will only be started when the user issues the INITiate command

Example: "CONF: BURS: EVM: ECAR" FSP-K90 option is configured to run a EVM versus carrier measurement.

Characteristics: *RST value: -
SCPI: Device Specific

Mode: K90

CONFigure:BURSt:EVM:ESYMBOL[:IMMediate]

This remote control command configures the FSP-K90 measurement type to be EVM Versus Symbol. After this command has been executed, the specified measurement will only be started when the user issues the INITiate command

Example: "CONF: BURS: EVM: ESYM" FSP-K90 option is configured to run a EVM versus symbol measurement.

Characteristics: *RST value: -
SCPI: Device Specific

Mode: K90

CONFigure:BURSt:SPECTrum:MASK[:IMMediate]

This remote control command configures the FSP-K90 measurement type to be Spectrum mask. After this command has been executed, the specified measurement will only be started when the user issues the INITiate command

Example: "CONF: BURS: SPEC: MASK" FSP-K90 option is configured to run a Spectrum Mask measurement.

Characteristics: *RST value: -
SCPI: Device Specific

Mode: K90

CONFigure:BURSt:SPECTrum:ACPR[:IMMediate]

This remote control command configures the FSP-K90 measurement type to be ACPR (adjacent channel power relative) After this command has been executed, the specified measurement will only be started when the user issues the INITiate command

Example: "CONF: BURS: SPEC: ACPR" FSP-K90 option is configured to run a ACPR measurement.

Characteristics: *RST value: -
SCPI: Device Specific

Mode: K90

CONFigure:BURSt:CONStellation:CCARrier[:IMMediate]

This remote control command configures the FSP-K90 measurement type to be Constellation versus Carrier. After this command has been executed, the specified measurement will only be started when the user issues the INITiate command

Example: “CONF: BURS: CONS: CCAR” FSP-K90 option is configured to run a Constellation versus Carrier measurement.

Characteristics: *RST value: -
SCPI: Device Specific

Mode: K90

CONFigure:BURSt:CONStellation:CSYMBOL[:IMMediate]

This remote control command configures the FSP-K90 measurement type to be Constellation versus Symbol. After this command has been executed, the specified measurement will only be started when the user issues the INITiate command

Example: “CONF: BURS: CONS: CSYM” FSP-K90 option is configured to run a Constellation versus Symbol measurement.

Characteristics: *RST value: -
SCPI: Device Specific

Mode: K90

CONFigure:BURSt:CONStellation:CARRier:SElect

This remote control command is only available when Constellation versus Symbol measurement is selected. When the Constellation versus Symbol measurement is initiated, it will calculate the results of the selected carrier.

Example: “CONF: BURS: CONS: CARR: SEL -14” - Carrier -14 is selected.
 “CONF: BURS: CONS: CARR: SEL 10” - Carrier 10 is selected.
 “CONF: BURS: CONS: CARR: SEL ALL” - All carriers are selected.
 “CONF: BURS: CONS: CARR: SEL PIL” - Pilots only.

Characteristics: *RST value: ALL
SCPI: Device Specific

Mode: K90

DISPlay Subsystem

The DISPlay subsystem controls the selection and presentation of textual and graphic information as well as of measurement data on the display.

COMMAND	PARAMETERS	UNIT	COMMENT
:DISPLAY			
:FORMat	SPLit SINGLE		
[:WINDow<1 2>]			
:SElect			
:SSElect			
:TABLe	<boolean>		
:TRACe<1...3>			
:Y			
[:SCALe]			
:AUTO	<boolean>		
:PDIVision	<numeric_value>	DB	
:RLEVel			
:OFFSet	<numeric_value>		

DISPlay:FORMat

This command sets the visible screen display type to full or split screen.

Example: "DISP:FORM SINGLE" Sets the FS_K90 display to full screen.

Characteristics: *RST value: SPL
SCPI: Device Specific

Mode: K90

DISPlay[:WINDow<1|2>]:SElect

This command selects whether screen A or screen B is active

Example: "DISP:WIND1:SEL" Sets the FS_K90 screen A active.

Characteristics: *RST value: -
SCPI: Device Specific

Mode: K90

DISPlay[:WINDow<1|2>]:SSElect

This is an alias for DISPlay:WINDow[1|2]:SElect. SSElect means Screen SElect.

Example: "DISP:WIND1:SSEL" Sets the FS_K90 screen A active.

Characteristics: *RST value: 1
SCPI: Device Specific

Mode: K90

DISPlay[:WINDow<1|2>]:TABLe

This command selects whether the results table is displayed

Example: "DISP:WIND1:TABL 0" Hides the results table

Characteristics: *RST value: 0
SCPI: Device Specific

Mode: K90

DISPlay[:WINDow<1|2>]:TRACe1:Y[:SCALe]:AUTO

This command switches on or off automatic scaling of the Y-axis for the specified trace display. Automatic scaling sets the Y-axis to automatically scale to best fit the measurement results. This command is current only supported for EVM vs Carrier and EVM vs Symbol.

Example: "DISP:WIND2:TRAC:Y:SCAL:AUTO ON" switches on automatic scaling of the Y-axis for the active trace

Characteristics: *RST value: ON
SCPI: conforming

Mode: K90

DISPlay[:WINDow<1|2>]:TRACe1:Y[:SCALe]:PDIVision

This command sets the size of each Y scale division for the specified trace display. Note that this command has no affect if automatic scaling of the Y-axis is enabled. This command is current only supported for EVM vs Carrier and EVM vs Symbol.

Example: "DISP:WIND2:TRAC:Y:SCAL:DPIV 2" Sets the Y scale division to size to 2

Characteristics: *RST value: 3
SCPI: conforming

Mode: K90

DISPlay[:WINDow<1|2>]:TRACe<1...3>:Y[:SCALe]:RLEVel:OFFSet

This remote control command specifies the external attenuation/gain applied to measurements. The value corresponds to the reference level offset in spectrum analyzer mode. The numeric suffix at WINDow<1|2> and TRACe<1 to 3> are irrelevant.

Example: "DISP:TRAC:Y:RLEV:OFFS 10" external attenuation (level offset) of the analyzer is 10dB
"DISP:TRAC:Y:RLEV:OFFS -10" external attenuation of the analyzer is -10dB. i.e. a gain of 10dB

Characteristics: *RST value: 0 dB
SCPI: conforming

Mode: K90

FETCh – Subsystem

The FETCh subsystem contains commands for reading out results of complex measurement tasks. This subsystem is closely linked to the CONFigure and SENSE subsystems.

COMMAND	PARAMETERS	UNIT	COMMENT
FETCh			
:BURSt			
:ALL?		--	query only
:FERRor			
:AVERage?		HZ	query only
:MINimum?		HZ	query only
:MAXimum?		HZ	query only
:SYMBolerror			
:AVERage?			query only
:MINimum?			query only
:MAXimum?			query only
:IQOFset			
:AVERage?		DB	query only
:MINimum?		DB	query only
:MAXimum?		DB	query only
:GIMBalance			
:AVERage?		DB	query only
:MINimum?		DB	query only
:MAXimum?		DB	query only
:QUADoffset			
:AVERage?		DEG	query only
:MINimum?		DEG	query only
:MAXimum?		DEG	query only
:EVM			
:ALL			
:AVERage?		DB	query only
:MINimum?		DB	query only
:MAXimum?		DB	query only
:DATA			
:AVERage?		DB	query only
:MINimum?		DB	query only
:MAXimum?		DB	query only
:PILot			
:AVERage?		DB	query only
:MINimum?		DB	query only
:MAXimum?		DB	query only

FETCh:BURSt:ALL?

This command returns all the results. The results are output as a list of result strings separated by ',' in the following (ASCII) format:

<min frequency error>, <average frequency error>, <max frequency error>,
 <min symbol error>, <average symbol error>, <max symbol error>,
 <min IQ offset>, <average IQ offset>, <maximum IQ offset>,
 <min gain imbalance>, <average gain imbalance>, <max gain imbalance>,
 <min quadrature offset>, <average quadrature offset>, <max quadrature offset>,
 <min EVM all bursts>, <average EVM all bursts>, <max EVM all bursts>,
 <min EVM data carriers>, <average EVM data carriers >, <max EVM data carriers >
 <min EVM pilots>, <average EVM pilots >, <max EVM pilots >

Note that the units for the EVM results are specified with the UNITS:EVM command

Example: "FETC:BURS:ALL?" All calculated results are returned

Characteristics: *RST value: -
 SCPI: Device Specific

Mode: K90

FETCh:BURSt:FERRor

This command returns the measured average, minimum or maximum frequency errors in Hertz

Example: "FETC:BURS:FERR:MAX?" The maximum frequency error from the most recent measurement is returned.

Characteristics: *RST value: -
 SCPI: Device Specific

Mode: K90

FETCh:BURSt:SYMBolerror

This command returns the percentage of symbols that were outside permissible de-modulation range within a burst.

Example: "FETC:BURS:SYMB:MAX?" The maximum number of symbols that were out of range per burst.

Characteristics: *RST value: -
 SCPI: Device Specific

Mode: K90

FETCh:BURSt:IQOFfset

This command returns the measured average, minimum or maximum IQ Offset errors in dB.

Example: "FETC:BURS:IQOF:MAX?" The maximum IQ Offset error from the most recent measurement is returned.

Characteristics: *RST value: -
 SCPI: Device Specific

Mode: K90

FETCh:BURSt:GIMBalance

This command returns the measured average, minimum or maximum IQ Imbalance errors in dB.

Example: "FETC: BURS: GIMB: MAX?" The maximum IQ Imbalance error from the most recent measurement is returned.

Characteristics: *RST value: -
SCPI: Device Specific

Mode: K90

FETCh:BURSt:QUADoffset

This command returns the accuracy in terms of the phase error of symbols within a burst.

Example: "FETC: BURS: QUAD: MAX?" The maximum angle error recorded for a symbol during the measurement.

Characteristics: *RST value: --
SCPI: Device Specific

Mode: K90

FETCh:BURSt:EVM:ALL

This command returns the Error Vector Magnitude measurement results summary (average, minimum or maximum value) in dB. This is a combined figure that represents the pilot, data and the free carrier.

Example: "FETC: BURS: EVM: ALL: MAX?" The maximum EVM recorded for all measurement carrier is returned.

Characteristics: *RST value: -
SCPI: Device Specific

Mode: K90

FETCh:BURSt:EVM:DATA

This command returns the Error Vector Magnitude measurement results summary for the data carrier (average, minimum or maximum value) in dB.

Example: "FETC: BURS: EVM: DATA: MAX?" The maximum EVM recorded for the data carrier is returned.

Characteristics: *RST value: -
SCPI: Device Specific

Mode: K90

FETCh:BURSt:EVM:PILot

This command returns the Error Vector Magnitude measurement results summary for the EVM pilot carrier (average, minimum or maximum value) in dB.

Example: "FETC: BURS: EVM: PIL: MAX?" The maximum EVM recorded for the EVM pilot carrier is returned.

Characteristics: *RST value: -
SCPI: Device Specific

Mode: K90

INITiate Subsystem

The INITiate subsystem configures the instrument prior to a measurement being carried out. It is basically used to tell the instrument which measurement is to be performed and takes any necessary step to set up the instrument for the measurement.

COMMAND	PARAMETERS	UNIT	COMMENT
INITiate [:IMMEDIATE] :CONTinuous	<Boolean>		no query no query

INITiate[:IMMEDIATE]

This remote control command requests the FS- K90 option to start a new measurement sequence. If a measurement sequence is already in progress, then the command will be ignored.

Example: “INIT” - The FS- K90 option will attempt to start a new measurement.

Characteristics: *RST value: -
SCPI: Conforming

Mode: K90

INITiate:CONTinuous

This command determines whether the trigger system is continuously initiated (continuous) or performs single measurements (single).

Example: “INIT:CONT OFF” The FS- K90 option will attempt a non continuous measurement when initiated.

Characteristics: *RST value: 0
SCPI: Conforming

Mode: K90

INPut Subsystem

The INPut subsystem controls the input characteristics of the RF inputs of the instrument.

COMMAND	PARAMETERS	UNIT	COMMENT
:INPut			
:SElect	AIQ RF		
:IQ			
:BALanced [:STATe]	<Boolean>		B71 Option Only
:IMPedance	50 1000		B71 Option Only

INPut:SElect

This remote control command specifies whether the baseband Inputs or RF input are the currently selected signal input. Note that baseband input requires option B71. When option B71 is not installed then only RF selection is allowed.

Example: "INPut:SEL AIQ" Select baseband Input

Characteristics: *RST value: RF
SCPI: conforming

Mode: K90

INPut:IQ:BALanced[:STATe]

This remote control command specifies whether the IQ inputs are symmetrical (balanced) or asymmetrical (unbalanced). Note that this command requires option B71.

Example: "INPut:IQ:BAL 1" Specifies symmetrical (balanced) IQ inputs.

Characteristics: *RST value: ON
SCPI: Device Specific

Mode: K90

INPut:IQ:IMPedance

This remote control command specifies the input impedance for the IQ inputs. Note that this command requires option B71.

Example: "INPut:IQ:IMP 50" Specifies 50 Ohm input impedance for IQ inputs.

Characteristics: *RST value: 50
SCPI: Device Specific

Mode: K90

INSTrument Subsystem

COMMAND	PARAMETERS	UNIT	COMMENT
INSTrument :SElect :NSElect	WLAN <numeric_value>		

INSTrument:SElect

This remote control command selects active operation of the FSP-K90 option by specifying its name.

Example: "INST:SEL WLAN" The FSP-K90 option will be selected as the active option.

Characteristics: *RST value: SAN
SCPI: Device Specific

Mode: FSP Base System

INSTrument:NSElect

This remote control command selects active operation of the FSP-K90 option by specifying its associated option number.

Example: "INST:NSEL 16" The FSP-K90 option will be selected as the active option.

Characteristics: *RST value: 1
SCPI: Device Specific

Mode: FSP Base System

SENSe Subsystem

The SENSE command is used to set and get the values of parameters in the remote instrument. The get variant of the SENSE command differs from set in that it takes no parameter values (unless otherwise stated) but is followed by the character '?' and will return the parameter's value in the same format as it is set.

e.g SENS:FREQ 10GHZ - sets the frequency to 10 GHz
 SENS:FREQ? - response 10GHZ - returns the current frequency

COMMAND	PARAMETERS	UNIT	COMMENT
[SENSe]			
:FREQuency			
:CENTer	<numeric_value>	Hz	
:IQ			
:DITHer			
[:STATe]	<Boolean>		B71 Option Only
:LPASs			
[:STATe]	<Boolean>		B71 Option Only
:SWEep			
:TIME	<numeric_value>	S	
:DEMod			
:CESTimation	<Boolean>		
:FORMat			
:BANalyze	<String>		
:BTYPe	<String>		
:SYMBols			
:EQUal	<Boolean>		
:MIN	<numeric_value>		
:MAX	<numeric_value>		
:BURSt			
:COUNT	<numeric_value>		
:STATe	<Boolean>		
:SWAPiq	<Boolean>		
:TRACKing			
:LEVel	<Boolean>		
:PHASe	<Boolean>		
:TIME	<Boolean>		

[SENSe]:FREQuency:CENTer

The remote control command is used to specify the frequency that the Analyzer will use to make measurements against the input signal. Note that this command requires option B71.

Example: "SENS:FREQ:CENT 5GHZ" The FSP-K90 option uses the specified frequency value to set the analyzer detection frequency.

Characteristics: *RST value: $f_{max} / 2$
 SCPI: conforming

Mode: K90

[SENSe]:IQ:DITHer[:STATe]

This instruction links a 2 MHz broad intoxication signal with 42.67 MHz into the signal path of the baseband inputs. Note that this command requires option B71

Example: "SENS:IQ:DITH 1" switches on the 2 MHz broad intoxication signal

Characteristics: *RST value: FALSE
SCPI: conforming

Mode: K90

[SENSe]:IQ:LPASs[:STATe]

This instruction switches a 36 MHz filter into the I and Q branch of the baseband inputs. Note that this command requires option B71

Example: "SENS:IQ:LPASs 1" Switches on the low pass filter for the IQ inputs.

Characteristics: *RST value: FALSE
SCPI: conforming

Mode: K90

[SENSe]:SWEep:TIME

The remote control command is used to specify the sweep acquisition period (capture time) for which the input signal is to be measured.

Example: "SENS:SWEep:TIME 20ms" The FSP-K90 option uses the specified sweep acquisition period.

Characteristics: *RST value: 1ms
SCPI: conforming

Mode: K90

[SENSe]:DEMod:CESTimation

This command defines whether channel estimation will be done in preamble & payload (if set to 1) or only in preamble (if set to 0). The effect of this is most noticeable for the EVM measurement results, where the results will be improved when this feature is enabled.

However, this functionality is not supported by the IEEE 802.11a standard and must be disabled if the results are to be checked against the standard.

Example: "SENS:DEMod:CEST 1" Specifies that the IQ measurement results will use channel estimation in preamble & payload.

Characteristics: *RST value: 0
SCPI: device specific

Mode: K90

SENSe]:DEMod:FORMat:BANalyze

The remote control command sets the analysis modulation format that will be assumed when the measurement is performed. If the [SENSe:]DEMod:FORMat:SIGSymbol parameter has been set to TRUE then this command can be used to measure only certain burst types within a measurement sequence.

The supplied string can be one of the following:

'BPSK' - IEEE 802.11a, Hiperlan2 - BI-Phase shift keying
 'QPSK' - IEEE 802.11a, Hiperlan2 - Quadrature phase shift keying
 'QAM16' - IEEE 802.11a, Hiperlan2 - Quadrature Amplitude Modulation
 'QAM64' - IEEE 802.11a, Hiperlan2 - Quadrature Amplitude Modulation – higher data rate

Example: "SENS:DEMod:FORM:BAN `QAM16`" The FSP-K90 option will only analyze bursts that are of the QAM16 modulation format

Characteristics: *RST value: 'QAM64'
 SCPI: device specific

Mode: K90

[SENSe]:DEMod:FORMat:BANalyze:BTYPe

This remote control command specifies the type of burst to be analyzed. Only bursts of the specified type take part in measurement analysis.

The supplied string can be one of the following:

'DIRECT' - IEEE 802.11a - Only possible burst type for the IEEE 802.11a standard

Example: "SENS:DEMod:FORM:BAN:BTYPe `DIRECT`" The FSP-K90 option will only analyze DIRECT bursts

Characteristics: *RST value: 'DIRECT'
 SCPI: device specific

Mode: K90

[SENSe]:DEMod:BANalyze:SYMBOLs:EQUal

When this command is set to TRUE then only bursts of equal length will take part in the PVT analysis. When this command is set to true the value specified by the [SENSe:]DEMod:BANalyze:SYMBOLs:MIN command specifies the number of symbols that a burst must have in order to take part in PVT analysis

Example: "SENS:DEMod:BAN:SYM:EQU 1" Only bursts of equal length will take part in the PVT analysis.

Characteristics: *RST value: 0
 SCPI: device specific

Mode: K90

[SENSe]:DEMod:BANalyze:SYMBOLS:MIN

This command specifies the number of data symbols required for bursts to qualify for measurement analysis. Only bursts with the specified number of symbols will be used in the measurement analysis. The number of data symbols is defined as the uncoded bits including service and tail bits.

When the [SENSe:]DEMod:BANalyze:SYMBOLS:EQUAL command has been set to true then this command specifies the exact number of symbols required for a burst to take part in measurement analysis. When the [SENSe:]DEMod:BANalyze:SYMBOLS:EQUAL command is set to false this command specifies the minimum number of symbols required for a burst to take part in measurement analysis.

Example: "SENS:DEMod:BAN:SYM:MIN 16" The FSP-K90 option will only analyze bursts which contain a symbol count of 16.

Characteristics: *RST value: 1
 SCPI: device specific

Mode: K90

[SENSe]:DEMod:BANalyze:SYMBOLS:MAX

This command specifies the maximum number of data symbols required for bursts to qualify for measurement analysis. Only bursts with the specified number of symbols will be used in the measurement analysis. The number of data symbols is defined as the uncoded bits including service and tail bits.

This value will not have any immediate effect if the [SENSe:]DEMod:BANalyze:SYMBOLS:EQUAL command has been set to true as in this case no range of symbols is allowed and only bursts with exactly the number of symbols specified by the [SENSe:]DEMod:BANalyze:SYMBOLS:MIN command shall take place in measurement analysis

Example: "SENS:DEMod:BAN:SYM:MAX 1300" The FSP-K90 option will only analyze bursts which contain a maximum symbol count of 1300.

Characteristics: *RST value: 64
 SCPI: device specific

Mode: K90

[SENSe]:BURSt:COUNT

This command defines the number of bursts that will be analyzed by the measurement.

Example: "BURSt:COUNT 16" - Sets the number of bursts to 16.

Characteristics: *RST value: 1
 SCPI: device specific

Mode: K90

[SENSe]:BURSt:COUNT:STATe

When this command is set to on, the burst count parameter will be used by the measurement, otherwise the burst count parameter will be ignored.

Example: "BURSt:COUNT:STAT 1" Sets the burst count state to ON

Characteristics: *RST value: OFF
 SCPI: device specific

Mode: K90

[SENSe]:SWAPiq

This command defines whether or not the recorded IQ pairs should be swapped (I<->Q) before being processed.

Example: "SWAP 1" Specifies that IQ values should be swapped.

Characteristics: *RST value: 0
SCPI: device specific

Mode: K90

[SENSe]:TRACKing:LEVel

This command defines whether or not the measurement results should be compensated for level

Example: "TRACK:LEV 1" - Specifies that the measurement results should be compensated for level.

Characteristics: *RST value: 0
SCPI: device specific

Mode: K90

[SENSe]:TRACKing:PHASe

This command defines whether or not the measurement results should be compensated for phase

Example: "TRACK:PHAS 1" Specifies that the measurement results should be compensated for phase.

Characteristics: *RST value: 1
SCPI: device specific

Mode: K90

[SENSe]:TRACKing:TIME

This command defines whether or not the measurement results should be compensated for time

Example: "TRACK:TIME 1" Specifies that the measurement results should be compensated for time.

Characteristics: *RST value: 0
SCPI: device specific

Mode: K90

STATus Subsystem

The STATus subsystem contains the commands for the status reporting system (See Section Status reporting registers). *RST does not influence the status registers.

COMMAND	PARAMETERS	UNIT	COMMENT
:STATus:			
:QUESTionable			
:LIMit<1 2>			
[:EVENT]?	--	--	
:CONDition?	--	--	
:ENABLE	0 to 65535	--	
:PTRansition	0 to 65535	--	
:NTRansition	0 to 65535	--	
:POWer			
[:EVENT]?	--	--	
:CONDition?	--	--	
:ENABLE	0 to 65535	--	
:PTRansition	0 to 65535	--	
:NTRansition	0 to 65535	--	

STATus:QUESionable:LIMit<1|2>[:EVENT]?

This command queries the contents of the EVENT section of the STATus:QUESTionable:LIMit Register for screen A and B. Readout deletes the contents of the EVENT section.

Example: "STAT:QUES:LIM?"

Characteristics: *RST value: -
SCPI: Device Specific

Mode: K90

STATus:QUESionable:LIMit<1|2>:CONDition?

This command queries the contents of the CONDition section of the STATus:QUESTionable:LIMit register for screen A and B. Readout does not delete the contents of the CONDition section.

Example: "STAT:QUES:LIM:COND?"

Characteristics: *RST value: -
SCPI: Device Specific

Mode: K90

STATus:QUESionable:LIMit<1|2>:ENABLE

This command sets the bits of the ENABLE section of the STATus:QUESTionable:LIMit register for screen A and B. The ENABLE register selectively enables the individual events of the associated EVENT section for the summary bit.

Example: "STAT:QUES:LIM:ENAB 65535" All events bits will be represented in the LIMit summary bit.

Characteristics: *RST value: -
SCPI: Device Specific

Mode: K90

STATus:QUESionable:LIMit<1|2>:PTRansition

This command determines what bits in the STATus:QUESionable:LIMit Condition register of screen A or B will set the corresponding bit in the STATus:QUESionable:LIMit Event register when that bit has a positive transition (0 to 1). The variable <number> is the sum of the decimal values of the bits that are to be enabled.

Example: "STAT:QUES:LIMit:PTR 65535" -All condition bits will be summarised in the Event register when a positive transition occurs.

Characteristics: *RST value: -
SCPI: Device Specific

Mode: K90

STATus:QUESionable:LIMit<1|2>:NTRansition

This command determines what bits in the STATus:QUESionable:LIMit Condition register of screen A or B will set the corresponding bit in the STATus:QUESionable:LIMit Event register when that bit has a negative transition (1 to 0). The variable <number> is the sum of the decimal values of the bits that are to be enabled.

Example: "STAT:QUES:LIM:NTR 65535" All condition bits will be summarised in the Event register when a positive transition occurs.

Characteristics: *RST value: -
SCPI: Device Specific

Mode: K90

STATus:QUESionable:POWer[:EVENT]?

This command queries the contents of the EVENT section of the STATus:QUESTionable:POWer Register. Readout deletes the contents of the EVENT section.

Example: "STAT:QUES:POW?"

Characteristics: *RST value: -
SCPI: Device Specific

Mode: K90

STATus:QUESionable:POWer:CONDition?

This command queries the contents of the CONDition section of the STATus:QUESTionable:POWer register. Readout does not delete the contents of the CONDition section.

Example: "STAT:QUES:POW:COND?"

Characteristics: *RST value: -
SCPI: Device Specific

Mode: K90

STATus:QUESionable:POWer:ENABLE

This command sets the bits of the ENABLE section of the STATus:QUESionable:POWer register. The ENABLE register selectively enables the individual events of the associated EVENT section for the summary bit.

Example: "STAT:QUES:POW:ENAB 65535" - All events bits will be represented in the POWER summary bit.

Characteristics: *RST value: -
SCPI: Device Specific

Mode: K90

STATus:QUESionable:POWer:PTRansition

This command determines what bits in the STATus:QUESionable:POWer Condition register will set the corresponding bit in the STATus:QUESionable:POWer Event register when that bit has a positive transition (0 to 1).The variable <number> is the sum of the decimal values of the bits that are to be enabled.

Example: "STAT:QUES:POWer:PTR 65535" All condition bits will be summarised in the Event register when a positive transition occurs.

Characteristics: *RST value: -
SCPI: Device Specific

Mode: K90

STATus:QUESionable:POWer:NTRansition

This command determines what bits in the STATus:QUESionable:POWer Condition will set the corresponding bit in the STATus:QUESionable:POWer Event register when that bit has a negative transition (1 to 0).The variable <number> is the sum of the decimal values of the bits that are to be enabled.

Example: "STAT:QUES:POW:NTR 65535" - All condition bits will be summarised in the Event register when a positive transition occurs.

Characteristics: *RST value: -
SCPI: Device Specific

Mode: K90

TRACe Subsystem

The TRACe subsystem controls access to the instrument’s internal trace memory.

COMMAND	PARAMETERS	UNIT	COMMENT
TRACe [:DATA]	TRACE1 TRACE2 TRACE3 TRACE4 TRACE5 TRACE6		Query only
:IQ :DATA: :MEMory?	<numeric_value>,<numeric_value>		Query only

TRACE[:DATA]

This command returns all the measured data that relates to the currently selected measurement type. All results are returned in ASCII format. The returned data is particular to the currently selected measurement type and is specified below. DISPlay:FORMat is not supported with this command.

IQ Measurements

Currently, there are a number of measurements that can be performed in IQ mode. No data will be returned for any of the following measurements, should it be requested, until such time as a measurement belonging to the IQ group has been previously run.

Running a frequency sweep measurement for example, Spectrum Mask, will not generate results for this measurement group.

Constellation vs Symbol

This measurement represents I and Q data. Data will be returned as a repeating array of interleaved I and Q data in groups of selected carriers, until all the data is exhausted.

Each I and Q point will be returned in floating point format. TRACE1 is used for this measurement results.

If “All Carriers” is selected, it will return 52 per of I and Q data per symbol.

If “Pilots Only” is selected, it will return 4 per of I and Q per symbol in the following order: Carrier – 21, Carrier –7, Carrier 7, Carrier 21.

If a single carrier is selected, it will return 1 per of I and Q data per symbol.

Constellation vs Carrier

This measurement represents I and Q data. Data will be returned as a repeating array of interleaved I and Q data in groups of 53 channels including the channel 0, until all the data is exhausted.

Each I and Q point will be returned in floating point format. TRACE1 is used for this measurement results.

EVM vs Carrier

Two trace types are provided with this measurement. There is an average EVM value for each of the 53 channels or a repeating group of EVM values for each channel. The number of repeating groups will correspond to the number of fully analyzed trains.

Each EVM value will be returned as a floating point number, expressed in units of dBm.

TRACE1 – Average EVM values per channel

TRACE2 – All EVM values per channel for each full train of the capture period

EVM vs Symbol

Three traces types are available with this measurement. The basic trace types show either the minimum, mean or maximum EVM value, as measured over the complete capture period.

The number of repeating groups that are returned will be equal to the number of measured symbols.

Each EVM value will be returned as a floating point number, expressed in units of dBm.

TRACE1 – Minimum EVM values

TRACE2 – Mean EVM values

TRACE3 – Maximum EVM values

Frequency Sweep Measurements

Currently, there is only one measurement that is performed in frequency sweep mode. This is the Spectrum Mask measurement. No data will be returned for this measurement, should it be requested, until such time as a measurement has been previously run.

Running an IQ measurement will not generate results for this measurement.

Spectrum Mask

Result data will be returned as 625 trace points in floating point format. These trace points are obtained directly from the base system via the measurement API and the quantity is therefore a fixed value. Only an array of Y data will be returned. TRACE1 is used for this measurement results.

Spectrum ACPR

Result data will be returned as 625 trace points in floating point format. These trace points are obtained directly from the base system via the measurement API and the quantity is therefore a fixed value. Only an array of Y data will be returned. TRACE1 is used for this measurement results.

Example: "TRAC? TRACE2" The measurement data for the selected graph is returned.

Characteristics: *RST value: -
SCPI: conforming

Mode: K90

TRACE:IQ:DATA:MEMory?

Returns all the IQ data associated with the measurement acquisition time in interleaved format.

The result values are scaled linear in unit *Volt* and correspond to the voltage at the RF input of the instrument. The command returns a comma separated list of the measured voltage values in floating point format (Comma Separated Values = CSV). The number of values returned is 2 * number of samples, the first half being the I-values, the second half the Q-values.

Parameter: <offset samples> Offset of the values to be read related to the start of the acquired data. Value range: 0 to <# of samples> - 1
<# of samples> Number of measurement values to be read.
Value range: 1 to
<# of samples> - <offset samples>

Example: "TRAC:IQ:DATA:MEM? 0,2000" - Requests first 2000 samples.

Characteristics: *RST value: -
SCPI: device specific.

Mode: K90

Trigger Subsystem

The trigger subsystem is used to synchronize device action(s) with events.

COMMAND	PARAMETERS	UNIT	COMMENT
:TRIGger [:SEQuence] :MODE :LEVel :Power :AUTO :HOLDoff	IMMediate EXTernal POWer <numeric_value> <Boolean> <numeric_value>	 DBM V S	

TRIGger[:SEQuence]:MODE

This command configures how triggering is to be performed.

- Parameter:**
- IMMediate automatically triggers the next measurement at the end of the previous measurement. This corresponds to the FREE RUN setting.
 - EXTernal the next measurement is triggered by the signal at the external trigger input e.g. a Gated trigger
 - POWer triggering of the measurement via signals which are outside the measurement channel.

Example: "TRIG:MODE IMM" - AUTO triggering will occur for the next measurement at the specified video percentage value.

Characteristics: *RST value: IMMediate
SCPI: device specific

Mode: K90

TRIGger[:SEQuence]:LEVel:POWer

This command accepts the level of the input signal for which triggering will occur. The value is specified in dBm for RF input and Volts for base band inputs.

Example: "TRIG:LEV:POW 10 DBM" - Set to 10 dBm for RF measurement.
"TRIG:LEV:POW 1 V" - Set to 1 Volt for base band measurement.

Characteristics: *RST value: -20 DBM
SCPI: Device Specific

Mode: K90

TRIGger[:SEQuence]:LEVel:POWer:AUTO

This command specifies whether or not an automatic power trigger level calculation is performed before each main measurement. The setting of this command is ignored if the setting for TRIGger[:SEQuence]:MODE is not POWER.

Example: "TRIG:LEV:POW:AUTO 1" Specifies that an automatic power trigger level calculation should be performed before the start of each main measurement.

Characteristics: *RST value: 0
SCPI: Device Specific

Mode: K90

TRIGger[:SEQuence]:HOLDoff

This command defines the length of the trigger delay. A negative delay time (pretrigger) can be set.

Example: “TRIG:HOLD 500us” The FSP-K90 option use a holdoff period of 500µs after the trigger condition has been met.

Characteristics: *RST value: 0s
 SCPI: Conforming

Mode: K90

Unit Subsystem

The unit subsystem specifies the units for specific result types.

COMMAND	PARAMETERS	UNIT	COMMENT
:UNIT :EVM	DB PCT		

UNIT:EVM

This command specifies the units for EVM results.

Parameter: DB EVM results returned in dB
 PCT EVM results returned in %

Example: "UNIT:EVM PCT" - EVM results to be returned in %.

Characteristics: *RST value: DB
 SCPI: device specific

Mode: K90

Status reporting registers

The status reporting system (see Fig. 4-1) stores all information on the present operating state of the instrument, e.g. that the instrument presently carries out a calibration and on errors which have occurred. This information is stored in the status registers and in the error queue. The status registers and the error queue can be queried via IEC bus.

The information is of a hierarchical structure. The register status byte (STB) defined in IEEE 488.2 and its associated mask register service request enable (SRE) form the uppermost level. The STB receives its information from the standard event status register (ESR) which is also defined in IEEE 488.2 with the associated mask register standard event status enable (ESE) and registers STATus:OPERation and STATus:QUEStionable which are defined by SCPI and contain detailed information on the instrument.

The IST flag ("Individual STatus") and the parallel poll enable register (PPE) allocated to it are also part of the status reporting system. The IST flag, like the SRQ, combines the entire instrument status in a single bit. The PPE fulfils the same function for the IST flag as the SRE for the service request.

The output buffer contains the messages the instrument returns to the controller. It is not part of the status reporting system but determines the value of the MAV bit in the STB and thus is represented in

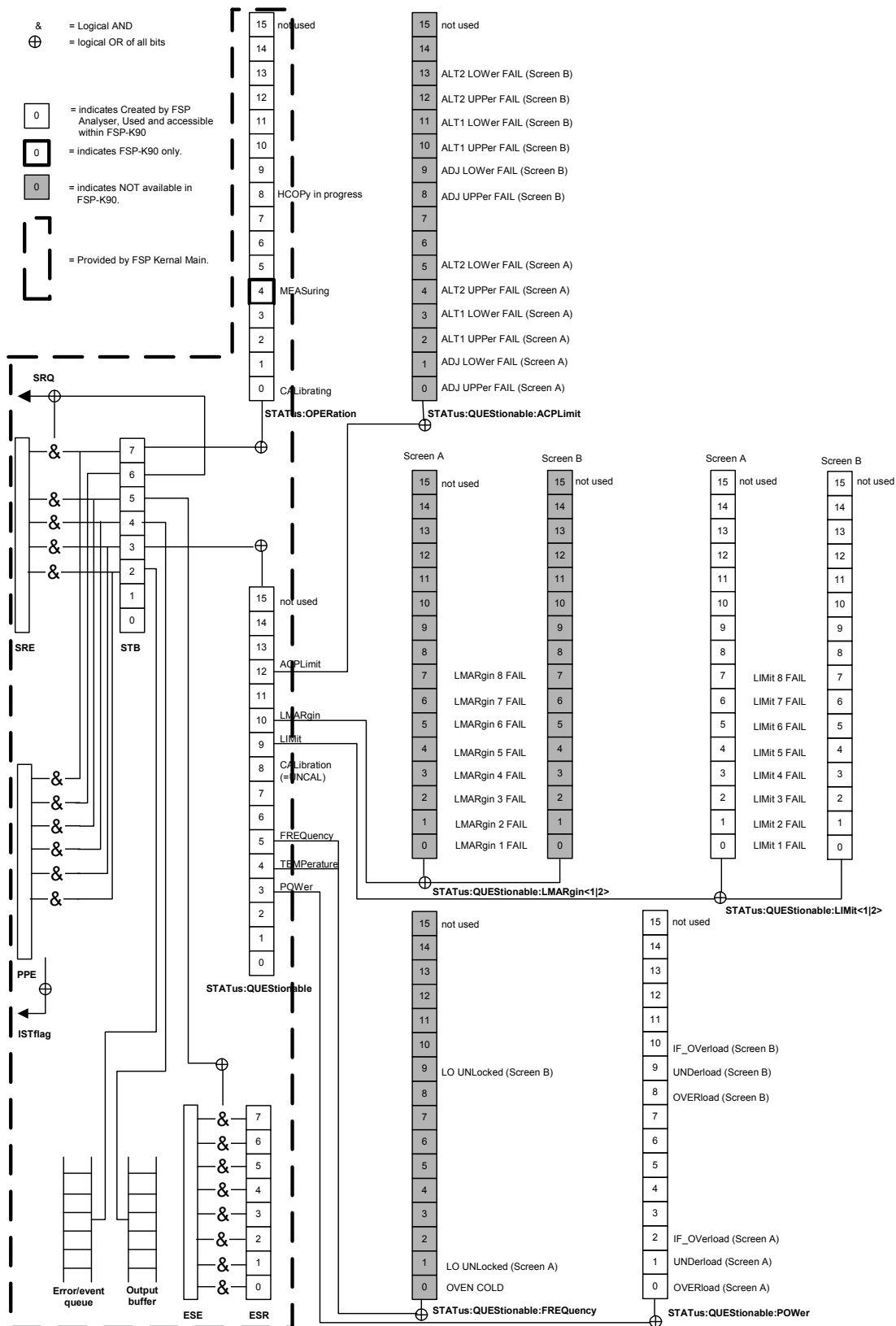

Fig. 4-1 Overview of the status registers

Description of the Status Registers

All the status registers shown in Fig. 4-1 are the same as those provided by the base system, with the exception of the following:

STATUS:OPERation – Although this register is provided by FSP Kernel main, FSP-K90 makes use of bits 4 & 7 in this register which are not used within FSP Kernel main

STATUS:QUESTIONable:ACPLimit – This register is provided by the analyser and is not available from the FSP-K90 command tree

STATUS:QUESTIONable:LIMit2 – This register is provided by the analyser and is not available from the FSP-K90 command tree

STATUS:QUESTIONable:LMARgin<1|2> – These registers are provided by the analyser and are not available from the FSP-K90 command tree

The deviations from the status register structure of the base system are detailed below.

STATUS:OPERation Register

In the CONDITION part, this register contains information on which actions the instrument is being executing or, in the EVENT part, information on which actions the instrument has executed since the last reading. It can be read using commands "STATUS:OPERation:CONDition?" or "STATUS:OPERation[:EVENT]?".

Bit No	Meaning
0	CALibrating This bit is set as long as the instrument is performing a calibration.
1 to 3	These bits are not used
4	MEASuring A '1' in this bit position indicates that a measurement is in progress. FSP-K90 only
5 to 7	These bits are not used
8	HardCOPy in progress This bit is set while the instrument is printing a hardcopy.
9 to 14	These bits are not used
15	This bit is always 0

STATus:QUEStionable Register

This register comprises information about indefinite states which may occur if the unit is operated without meeting the specifications. It can be queried by commands `STATus:QUEStionable:CONDition?` and `STATus:QUEStionable[:EVENT]?`.

Bit No	Meaning
0 to 2	These bits are not used
3	POWer This bit is set if a questionable power occurs (cf. also section "STATus:QUEStionable:POWer Register").
4	TEMPerature This bit is set if a questionable temperature occurs.
5	FREQuency The bit is set if a frequency is questionable (cf. section "STATus:QUEStionable:FREQuency Register").
6 to 7	These bits are not used
8	CALibration The bit is set if a measurement is performed uncalibrated (= ^ label "UNCAL")
9	LIMit (device-specific) This bit is set if a limit value is violated (see also section STATus:QUEStionable:LIMit Register). Note: Limit register is associated with limit lines for the Spectrum Mask measurement only.
10	LMARgin (device-specific) This bit is set if a margin is violated (see also section STATus:QUEStionable:LMARgin Register)
11	CORRection This bit is set if a questionable correction data occurs (see also section STATus:QUEStionable:CORRection. FSP-K90 only
12	ACPLimit This bit is set if a limit for the adjacent channel power measurement is violated (see also section "STATus:QUEStionable:ACPLimit Register").
13 to 14	These bits are not used
15	This bit is always 0

STATus:QUEStionable:LIMit Register

This register comprises information about the observance of limit lines in the corresponding measurement window (LIMit 1 corresponds to Screen A, LIMit 2 to Screen B). It can be queried with commands `STATus:QUEStionable:LIMit<1|2>:CONDition?` and `STATus:QUEStionable:LIMit<1|2>[:EVENT]?`.

Note that no limit lines are displayed in screen A and as such all bits in the LIMit1 register will always be set to 0.

Bit No	Meaning
0 to 4	These bits are not used
5	LIMit FAIL This bit is set if Spectrum Mask limit line is violated.
6 to 14	These bits are not used
15	This bit is always 0

Error Reporting

Error reporting for the K90 option is carried out using the Service Request (SRQ) interrupt in the GPIB interface. When an error occurs a Service Request interrupt will be generated. The master can then query the slave instrument for the error that triggered the interrupt Errors are queried through the "SYSTem:ERRor" command.

Table of softkeys with assignment of IEC/IEEE bus commands

Key LINES or Hotkey WLAN

GENERAL SETTINGS	<pre>:CONFigure:STANdard :[SENSe:]FREQuency:CENTer :CONFigure:CHANnel :CONFigure:POWer:AUTO :DISPlay[:WINDow<1 2>]:TRACe<1...3>:Y[:SCALE]:RLEVel:OFFSet :CONFigure:POWer:EXPEcted:RF :CONFigure:POWer:EXPEcted:IQ :[SENSe:]SWEep:TIME :[SENSe:]SWEep:COUNT :[SENSe:]BURSt:COUNT:STATe :[SENSe:]BURSt:COUNT :TRIGger[:SEQuence]:MODE :TRIGger[:SEQuence]:HOLDoff :TRIGger[:SEQuence]:LEVel:POWer :TRIGger[:SEQuence]:LEVel:POWer:AUTO :[SENSe:]SWAPiq :INPut:SElect :INPut:IQ:IMPedance :INPut:IQ:BALanced[:STATe] :[SENSe:]IQ:LPASs[:STATe] :[SENSe:]IQ:DITHer[:STATe]</pre>
DEMOM SETTINGS	<pre>:[SENSe:]DEMod:FORMat:SIGSymbol :[SENSe:]DEMod:FORMat:BANalyze:BTYPe :[SENSe:]DEMod:FORMat:AUTO :[SENSe:]DEMod:FORMat:BANalyze :[SENSe:]DEMod:BANalyze:SYMBOLs:EQual :[SENSe:]DEMod:BANalyze:SYMBOLs:MIN :[SENSe:]DEMod:BANalyze:SYMBOLs:MAX :[SENSe:]DEMod:CEStimation :[SENSe:]TRACKing:PHASe :[SENSe:]TRACKing:TIME :[SENSe:]TRACKing:LEVel</pre>
DISPLAY LIST GRAPH	<pre>:DISPlay[:WINDow<1 2>]:TABLE Result query: :FETCh:BURSt:ALL? :FETCh:BURSt:PREAmble? :FETCh:BURSt:PAYLoad? :FETCh:BURSt:RMS? :FETCh:BURSt:PEAK? :FETCh:BURSt:CRESt? :FETCh:BURSt:FERRor? :FETCh:BURSt:SYMBOLerror? :FETCh:BURSt:IQOffset :FETCh:BURSt:GIMBalance :FETCh:BURSt:QUADoffset :FETCh:BURSt:EVM:ALL :FETCh:BURSt:EVM:DATA :FETCh:BURSt:EVM:PILOt</pre>

PVT	:CONFigure:BURSt:PVT[:IMMediate]
GENERAL SETTINGS	:CONFigure:STANdard :[SENSe:]FREQuency:CENTer :CONFigure:CHANnel :CONFigure:POWer:AUTO :DISPlay[:WINDow<1 2>]:TRACe<1...3>:Y[:SCALe]:RLEVel:OFFSet :CONFigure:POWer:EXPEcted:RF :CONFigure:POWer:EXPEcted:IQ :[SENSe:]SWEep:TIME :[SENSe:]SWEep:COUNT :[SENSe:]BURSt:COUNT:STATe :[SENSe:]BURSt:COUNT :TRIGger[:SEQuence]:MODE :TRIGger[:SEQuence]:HOLDoff :TRIGger[:SEQuence]:LEVel:POWer :TRIGger[:SEQuence]:LEVel:POWer:AUTO :[SENSe:]SWAPiq :INPut:SElect :INPut:IQ:IMPedance :INPut:IQ:BALanced[:STATe] :[SENSe:]IQ:LPASs[:STATe] :[SENSe:]IQ:DITHer[:STATe]
DEMOM SETTINGS	:[SENSe:]DEMod:FORMat:SIGSymbol :[SENSe:]DEMod:FORMat:BANalyze:BTYPe :[SENSe:]DEMod:FORMat:AUTO :[SENSe:]DEMod:FORMat:BANalyze :[SENSe:]DEMod:BANalyze:SYMBOLs:EQUal :[SENSe:]DEMod:BANalyze:SYMBOLs:MIN :[SENSe:]DEMod:BANalyze:SYMBOLs:MAX :[SENSe:]DEMod:CEStimation :[SENSe:]TRACKing:PHASe :[SENSe:]TRACKing:TIME :[SENSe:]TRACKing:LEVel :DISPlay[:WINDow<1 2>]:TABLe
DISPLAY LIST GRAPH	
FULL BURST	:CONFigure:BURSt:PVT:SElect FULL
RISING - FALLING	:CONFigure:BURSt:PVT:SElect EDGE
GATING ON OFF	:[SENSe:]SWEep:EGATE
GATE SETTINGS	:[SENSe:]SWEep:EGATE:HOLDoff[:TIME] :[SENSe:]SWEep:EGATE:HOLDoff:SAMPle :[SENSe:]SWEep:EGATE:LENGth[:TIME] :[SENSe:]SWEep:EGATE:LENGth:SAMPle :[SENSe:]SWEep:EGATE:LINK

EVM

GENERAL
SETTINGS

```
:CONFigure:STANdard
:[SENSe:]FREQuency:CENTer
:CONFigure:CHANnel
:CONFigure:POWer:AUTO
:DISPlay[:WINDow<1|2>]:TRACe<1...3>:Y[:SCALE]:RLEVel:OFFSet
:CONFigure:POWer:EXPEcted:RF
:CONFigure:POWer:EXPEcted:IQ
:[SENSe:]SWEep:TIME
:[SENSe:]SWEep:COUNT
:[SENSe:]BURSt:COUNT:STATe
:[SENSe:]BURSt:COUNT
:TRIGger[:SEQuence]:MODE
:TRIGger[:SEQuence]:HOLDoff
:TRIGger[:SEQuence]:LEVel:POWer
:TRIGger[:SEQuence]:LEVel:POWer:AUTO
:[SENSe:]SWAPiq
:INPut:SElect
:INPut:IQ:IMPedance
:INPut:IQ:BALanced[:STATe]
:[SENSe:]IQ:LPASS[:STATe]
:[SENSe:]IQ:DITHer[:STATe]
```

DEMOD
SETTINGS

```
:[SENSe:]DEMod:FORMat:SIGSymbol
:[SENSe:]DEMod:FORMat:BANalyze:BTYPe
:[SENSe:]DEMod:FORMat:AUTO
:[SENSe:]DEMod:FORMat:BANalyze
:[SENSe:]DEMod:BANalyze:SYMBOLs:EQUal
:[SENSe:]DEMod:BANalyze:SYMBOLs:MIN
:[SENSe:]DEMod:BANalyze:SYMBOLs:MAX
:[SENSe:]DEMod:CESTimation
:[SENSe:]TRACKing:PHASe
:[SENSe:]TRACKing:TIME
:[SENSe:]TRACKing:LEVel
```

DISPLAY
LIST GRAPH

```
:DISPlay[:WINDow<1|2>]:TABLe
```

EVM VS
SYMBOL

```
:CONFigure:BURSt:EVM:ESYMBOL[:IMMediate]
```

EVM VS
CARRIER

```
:CONFigure:BURSt:EVM:ECARRIER[:IMMediate]
```

Y AXIS/
DIV

```
:DISPlay[:WINDow<1|2>]:TACel:Y[:SCALE]:AUTO
:DISPlay[:WINDow<1|2>]:TRACel:Y[:SCALE]:PDIVision
```

GATING
ON OFF

```
:[SENSe:]SWEep:EGATE
```

GATE
SETTINGS

```
:[SENSe:]SWEep:EGATE:HOLDoff[:TIME]
:[SENSe:]SWEep:EGATE:HOLDoff:SAMPle
:[SENSe:]SWEep:EGATE:LENGth[:TIME]
:[SENSe:]SWEep:EGATE:LENGth:SAMPle
:[SENSe:]SWEep:EGATE:LINK
```

SPECTRUM

GENERAL
SETTINGS

```
:CONFigure:STANdard
:[SENSe:]FREQuency:CENTer
:CONFigure:CHANnel
:CONFigure:POWer:AUTO
:DISPlay[:WINDow<1|2>]:TRACe<1...3>:Y[:SCALe]:RLEVel:OFFSet
:CONFigure:POWer:EXPEcted:RF
:CONFigure:POWer:EXPEcted:IQ
:[SENSe:]SWEep:TIME
:[SENSe:]SWEep:COUNT
:[SENSe:]BURSt:COUNT:STATE
:[SENSe:]BURSt:COUNT
:TRIGGer[:SEQuence]:MODE
:TRIGGer[:SEQuence]:HOLDoff
:TRIGGer[:SEQuence]:LEVel:POWer
:TRIGGer[:SEQuence]:LEVel:POWer:AUTO
:[SENSe:]SWAPiq
:INPut:SELect
:INPut:IQ:IMPedance
:INPut:IQ:BALanced[:STATE]
:[SENSe:]IQ:LPASs[:STATE]
:[SENSe:]IQ:DITHer[:STATE]
```

DEMODO
SETTINGS

```
:[SENSe:]DEMod:FORMat:SIGSymbol
:[SENSe:]DEMod:FORMat:BANalyze:BTYPe
:[SENSe:]DEMod:FORMat:AUTO
:[SENSe:]DEMod:FORMat:BANalyze
:[SENSe:]DEMod:BANalyze:SYMBOLs:EQUal
:[SENSe:]DEMod:BANalyze:SYMBOLs:MIN
:[SENSe:]DEMod:BANalyze:SYMBOLs:MAX
:[SENSe:]DEMod:CEStimation
:[SENSe:]TRACKing:PHASe
:[SENSe:]TRACKing:TIME
:[SENSe:]TRACKing:LEVel
```

DISPLAY
LIST GRAPH

```
:DISPlay[:WINDow<1|2>]:TABLe
```

SPECTRUM
FLATNESS

```
: CONFigure:BURSt:SPECTrum:FLATness[:IMMediate]
```

SPECTRUM
MASK

```
:CONFigure:BURSt:SPECTrum:MASK[:IMMediate]
```

SPECTRUM
FTT

```
:CONFigure:BURSt:SPECTrum:FFT[:IMMediate]
```

SPECTRUM
ACPR

```
:CONFigure:BURSt:SPECTrum:ACPR[:IMMediate]
```

GATING
ON OFF

```
Results:
:CALCulate<1|2>:MARKer<1>:FUNCTion:POWer:RESult[:CURRent]?
:CALCulate<1|2>:MARKer<1>:FUNCTion:POWer:RESult:MAXHold?
:[SENSe:]SWEep:EGATe
```

GATE
SETTINGS

```
:[SENSe:]SWEep:EGATe:HOLDoff[:TIME]
:[SENSe:]SWEep:EGATe:HOLDoff:SAMPle
:[SENSe:]SWEep:EGATe:LENGth[:TIME]
:[SENSe:]SWEep:EGATe:LENGth:SAMPle
:[SENSe:]SWEep:EGATe:LINK
```

CONSTELL	---
GENERAL SETTINGS	:CONFIgure:STANdard :[SENSe:]FREQuency:CENTer :CONFIgure:CHANnel :CONFIgure:POWer:AUTO :DISPlay[:WINDow<1 2>]:TRACe<1...3>:Y[:SCALe]:RLEVel:OFFSet :CONFIgure:POWer:EXPEcted:RF :CONFIgure:POWer:EXPEcted:IQ :[SENSe:]SWEep:TIME :[SENSe:]SWEep:COUNT :[SENSe:]BURSt:COUNT:STATe :[SENSe:]BURSt:COUNT :TRIGger[:SEQuence]:MODE :TRIGger[:SEQuence]:HOLDoff :TRIGger[:SEQuence]:LEVel:POWer :TRIGger[:SEQuence]:LEVel:POWer:AUTO :[SENSe:]SWAPiq :INPut:SElect :INPut:IQ:IMPedance :INPut:IQ:BALanced[:STATe] :[SENSe:]IQ:LPASs[:STATe] :[SENSe:]IQ:DITHer[:STATe]
DEMODO SETTINGS	: [SENSe:] DEMod: FORMat: SIGSymbol : [SENSe:] DEMod: FORMat: BANalyze: BTYPE : [SENSe:] DEMod: FORMat: AUTO : [SENSe:] DEMod: FORMat: BANalyze : [SENSe:] DEMod: BANalyze: SYMBols: EQUal : [SENSe:] DEMod: BANalyze: SYMBols: MIN : [SENSe:] DEMod: BANalyze: SYMBols: MAX : [SENSe:] DEMod: CESTimation : [SENSe:] TRACKing: PHASe : [SENSe:] TRACKing: TIME : [SENSe:] TRACKing: LEVel
DISPLAY LIST GRAPH	:DISPlay[:WINDow<1 2>]:TABLE
CONSTELL	:CONFIgure:BURSt:CONStellation:CSYMBOL[:IMMediate]
CONSTELL VS CARRIER	:CONFIgure:BURSt:CONStellation:CCARRIER[:IMMediate]
CARRIER SELECTION	:CONFIgure:BURSt:CONStellation:CARRIER:SElect
GATING ON OFF	: [SENSe:] SWEep: EGATe
GATE SETTINGS	: [SENSe:] SWEep: EGATe: HOLDoff[:TIME] : [SENSe:] SWEep: EGATe: HOLDoff: SAMPLe : [SENSe:] SWEep: EGATe: LENGth[:TIME] : [SENSe:] SWEep: EGATe: LENGth: SAMPLe : [SENSe:] SWEep: EGATe: LINK

STATISTICS	---
GENERAL SETTINGS	<pre> :CONFigure:STANdard :[SENSe:]FREQuency:CENTer :CONFigure:CHANnel :CONFigure:POWer:AUTO :DISPlay[:WINDow<1 2>]:TRACe<1...3>:Y[:SCALe]:RLEVel:OFFSet :CONFigure:POWer:EXPEcted:RF :CONFigure:POWer:EXPEcted:IQ :[SENSe:]SWEep:TIME :[SENSe:]SWEep:COUNT :[SENSe:]BURSt:COUNT:STATE :[SENSe:]BURSt:COUNT :TRIGGer[:SEQuence]:MODE :TRIGGer[:SEQuence]:HOLDoff :TRIGGer[:SEQuence]:LEVel:POWer :TRIGGer[:SEQuence]:LEVel:POWer:AUTO :[SENSe:]SWAPiq :INPut:SELEct :INPut:IQ:IMPedance :INPut:IQ:BALanced[:STATE] :[SENSe:]IQ:LPASs[:STATE] :[SENSe:]IQ:DITHer[:STATE] :[SENSe:]DEMod:FORMat:SIGSymbol :[SENSe:]DEMod:FORMat:BANalyze:BTYPe :[SENSe:]DEMod:FORMat:AUTO :[SENSe:]DEMod:FORMat:BANalyze :[SENSe:]DEMod:BANalyze:SYMBOLs:EQual :[SENSe:]DEMod:BANalyze:SYMBOLs:MIN :[SENSe:]DEMod:BANalyze:SYMBOLs:MAX :[SENSe:]DEMod:CEStimation :[SENSe:]TRACKing:PHASe :[SENSe:]TRACKing:TIME :[SENSe:]TRACKing:LEVel :DISPlay[:WINDow<1 2>]:TABLE </pre>
DEMODO SETTINGS	<pre> :CONFigure:BURSt:STATistics:CCDF[:IMMediate] </pre>
DISPLAY LIST GRAPH	<pre> :CONFigure:BURSt:STATistics:BSTReam[:IMMediate] </pre>
CCDF	<pre> :CONFigure:BURSt:STATistics:SFIeld [:IMMediate] </pre>
BIT STREAM	<pre> :[SENSe:]SWEep:EGATe </pre>
SIGNAL FIELD	<pre> :[SENSe:]SWEep:EGATe:HOLDoff[:TIME] :[SENSe:]SWEep:EGATe:HOLDoff:SAMPle :[SENSe:]SWEep:EGATe:LENGth[:TIME] :[SENSe:]SWEep:EGATe:LENGth:SAMPle :[SENSe:]SWEep:EGATe:LINK </pre>
GATING ON OFF	<pre> :DISPlay:FORMat SINGLE </pre>
GATE SETTINGS	<pre> :DISPlay:FORMat SPLit </pre>

Key DISP

FULL SCREEN	:DISPlay:FORMat SINGLE
SPLIT SCREEN	:DISPlay:FORMat SPLit

Key LINES

```
:CALCulate<1|2>:LIMit<1>:BURSt:ALL
:CALCulate<1|2>:LIMit<1>:BURSt:ALL:RESUlt
:CALCulate<1|2>:LIMit<1>:BURSt:FERRor[:AVERAge]
:CALCulate<1|2>:LIMit<1>:BURSt:FERRor[:AVERAge]:RESUlt
:CALCulate<1|2>:LIMit<1>:BURSt:FERRor:MAXimum
:CALCulate<1|2>:LIMit<1>:BURSt:FERRor:MAXimum:RESUlt
:CALCulate<1|2>:LIMit<1>:BURSt:IQOFFset[:AVERAge]
:CALCulate<1|2>:LIMit<1>:BURSt:IQOFFset[:AVERAge]:RESUlt
:CALCulate<1|2>:LIMit<1>:BURSt:IQOFFset:MAXimum
:CALCulate<1|2>:LIMit<1>:BURSt:IQOFFset:MAXimum:RESUlt
:CALCulate<1|2>:LIMit<1>:BURSt:EVM:ALL[:AVERAge]
:CALCulate<1|2>:LIMit<1>:BURSt:EVM:ALL[:AVERAge]:RESUlt
:CALCulate<1|2>:LIMit<1>:BURSt:EVM:ALL:MAXimum
:CALCulate<1|2>:LIMit<1>:BURSt:EVM:ALL:MAXimum:RESUlt
:CALCulate<1|2>:LIMit<1>:BURSt:EVM:DATA[:AVERAge]
:CALCulate<1|2>:LIMit<1>:BURSt:EVM:DATA[:AVERAge]:RESUlt
:CALCulate<1|2>:LIMit<1>:BURSt:EVM:DATA:MAXimum
:CALCulate<1|2>:LIMit<1>:BURSt:EVM:DATA:MAXimum:RESUlt
:CALCulate<1|2>:LIMit<1>:BURSt:EVM:PILot[:AVERAge]
:CALCulate<1|2>:LIMit<1>:BURSt:EVM:PILot[:AVERAge]:RESUlt
:CALCulate<1|2>:LIMit<1>:BURSt:EVM:PILot:MAXimum
:CALCulate<1|2>:LIMit<1>:BURSt:EVM:PILot:MAXimum:RESUlt
```

Key MKR

MARKR 1

```
:CALCulate<1|2>:MARKer<1>:STATe
:CALCulate<1|2>:MARKer<1>:X
:CALCulate<1|2>:MARKer<1>:Y
:CALCulate<1|2>:MARKer<1>:SYMBol
:CALCulate<1|2>:MARKer<1>:CARRier
:CALCulate<1|2>:MARKer<1>:FUNCTion:ZOOM 1
```

UNZOOM

MARKER ZOOM

```
:CALCulate<1|2>:MARKer<1>:FUNCTion:ZOOM <numeric value>
```

MARKER OFF

```
:CALCulate<1|2>:MARKer<1>:AOFF
```

Key MKR->

SELECT MARKER

```
---
```

MKR->TRACE

```
:CALCulate<1|2>:MARKer<1>:TRACe
```

Hotkeys

SPECTRUM	:INSTrument:SElect SANalyzer :INSTrument:NSElect 1
WLAN	---
AUTO LVL	---
RUN SGL	:INITiate:CONTinuous OFF; INITiate[:IMMediate]
RUN CONT	:INITiate:CONTinuous ON; INITiate[:IMMediate]
REFRESH	---
SCREEN A/B	:DISPlay[:WINDow<1 2>]:SElect :DISPlay[:WINDow<1 2>]:SSElect

5 List of Warnings & Error Messages

The list of possible warning & error messages are shown below :

Status Bar Message	Description
No bursts found	<p>This message is displayed if no valid burst was detected in the input data. To correct this problem check the following:</p> <ul style="list-style-type: none"> ➤ The connections between the DUT and analyzer are correct ➤ The input signal is of a sufficient level ➤ The capture time is long enough to capture at least one complete burst. If running with a Free Run trigger then the capture time must be greater than the burst length (ideally at least twice the burst length) to ensure that a complete burst is recorded. ➤ Check that the demod settings are correct
No bursts of desired type to analyze	<p>This message is displayed if bursts are found, but none of desired type to analyse. Check that the setting for Burst Type is correct.</p>
No signal found	<p>This message is displayed when an automatic level detection measurement is executed and the measured signal level is lower the permitted minimum value.</p>
Signal overload detected	<p>This message is displayed when the OVLD enhancement label is displayed and indicates that the input mixer is overloaded. If this message is displayed then try increasing the setting for the Signal Level parameter (or settings Auto Level). If this does not clear the problem then an external attenuation may need to be applied.</p>

6 Index

- (Key)	1.13	F	Frequency.....	2.13
0			Function Keys.....	1.13
0 to 9 (Key).....	1.13	H		
A		Hardkey		
Auto Level	1.7, 2.13	AMPT	1.12	
Auto Power Trigger Level	2.15	DISP	1.12	
B		FILE	1.12	
Burst Type.....	2.17	FREQ.....	1.12	
C		HCOPY	1.12	
Capture Time	2.14	MEAS	1.12	
Chan Est in Preamb and Payl.....	2.18	MKR	1.12	
Channel Number	2.13	MKR->	1.12	
Commands		PRESET	1.12	
assignment to soft key.....	4.37	SWEEP	1.12	
Constellation Vs Carrier.....	2.6	TRACE	1.12	
Constellation Vs Symbol.....	2.5	Hardkeys	1.12	
CTRL (Key)	1.13	Hotkey	1.8	
Cursor (Keys)	1.13, 1.15	AUTO LVL.....	1.9	
D		RUN CONT	1.9	
Demod	2.16	RUN SGL	1.9	
Demodulator.....	2.17	SCREEN [A B].....	1.9	
Display Settings.....	2.22	SPECTRUM	1.9	
E		WLAN.....	1.9	
Edit		I		
Checkbox Value	1.20	Installation	1.2	
Enumerated Value	1.19	Introduction.....	1.2	
Numeric Value	1.17	K		
ENTER (Key)	1.13	Keyboard	1.13	
Equal Burst Length.....	2.17	M		
Error Reporting.....	4.36	Marker		
ESC (Key)	1.13	Adjusting	2.19	
EVM Vs Carrier	2.4	Assigning to trace	2.21	
EVM Vs Symbol	2.3	Toggle Display.....	2.20	
Exiting the application.....	1.4	Zoom	2.20	
Ext Att	2.13	Markers	2.19	
		Max No of Data Symbols	2.18	
		Measurement		
		Automatic Level Detection	2.8	
		Frequency Sweep.....	2.7	
		IQ	2.2	
		Results	2.10	
		Running.....	2.9	
		Starting.....	1.7	
		Measurements.....	2.1	
		Min No of Data Symbols	2.17	
		Mouse.....	1.14	

N

Navigation	1.8
No of Burst to Analyze	2.14
No of Data Symbols	2.17

O

Overall Burst Count	2.14
---------------------------	------

P

Parameters	
Selecting & Editing	1.14
Selection using external keyboard	1.16
Selection using mouse	1.16
Power Level (RF)	2.15
Printing	1.23

Q

Quick Start	1.5
-------------------	-----

R

Results Summary	2.11
Rollkey	1.15

S

Save/Recall	1.22
Screen	
Full	2.22
Split	2.22
Settings	
Demod	2.16
General	2.12
Signal Level (RF)	2.14
Softkey	1.10
Demod Settings	2.16
GENERAL SETTINGS	2.12
Spectrum ACPR	2.8
Spectrum Mask	2.7
Standard	2.13
Starting the application	1.4
Status Bar	1.21
Status registers	4.33
Swap IQ	2.15

T

Title Bar	1.21
Tracking	
Level	2.18
Phase	2.18
Timing	2.18
Trigger Mode	2.15
Trigger Offset	2.15

W

Warnings & Error Messages	5.1
---------------------------------	-----